

Hotpoint

Refrigerator

User Manual

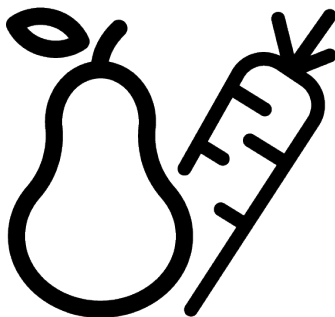

HPG2 9643IB XR4UK

15 7550 0376/ EN / AA/ 2/17/2026 12:03 PM
7291842056

Please read this manual first!

Our valued customer,

Thank you for choosing product. We want you to get the best results from your product, which is manufactured with high quality and technology. To do this, please read this entire manual and the other documents provided carefully before using the product.

Follow all the information and warnings in the user manual. This will protect you and your product from potential hazards. Keep the user manual. If you give the product to someone else, include the user manual with it.



The following symbols appear in the user manual and on the product:



Read the user manual.



Hazard that may result in death or injury.





  SUPPLIER'S NAME A MODEL IDENTIFIER → (*) A	The model information as stored in the product data base can be reached by entering following website and searching for your model identifier (*) found on energy label. https://eprel.ec.europa.eu/
---	---



1 Safety Instructions

- This section includes the safety instructions necessary to prevent the risk of personal injury or material damage.
- Our company shall not be held responsible for damages that may occur if these instructions are not observed.
- Always have installation and repair operations performed by manufacturer, authorized service or a person who will be described by importer company.
- Use original spare parts and accessories only.
- Do not repair or replace any component of the product unless it is clearly specified in the user manual.
- Do not perform any modifications on the product.

1.1 Important Safety Symbols

-  Risk of electric shock!
-  Read the user manual.
-  Danger that may result in burns due to contact with hot surfaces.
-  Combustible material, warning against fire hazard.
-  Risk of injury due to contact with sharp surfaces!

 Risk of UV-C radiation

1.2 Intention of Use

- This product is not suitable for commercial use and should not be used for a purpose other than its intended use.
- This product is intended for operating interiors, such as households or similar.

For example;

In the staff kitchens of the stores, offices and other working environments,

In farm houses,

In the units of hotels, motels or other resting facilities that are used by the customers,

In hostels, or similar environments,

In catering services and similar non-retail applications.

- This product shall not be used in open or enclosed external environments such as vessels, camper vans, balconies or terraces. Exposing the product to rain, snow, sunlight and wind may cause risk of fire.



1.3 Safety of Children, Vulnerable Persons and Pets

- This product may be used by children aged 8 years and older and persons with under-developed physical, sensory or mental capabilities or lack of experience and knowledge if they are being supervised or have been given instruction concerning use of the appliance in a safe way and the hazards involved.
- Children between 3 and 8 years are allowed to put and take out food into/from the cooler product.
- Children and pets must not play with, climb on, or get inside the product.
- Children and pets must be kept away from the cabin area (compressor) where electrical parts are located.
- Cleaning and user maintenance must not be performed by children unless there is someone overseeing them.
- Keep the packaging materials away from children. Risk of injury and suffocation.
- If there is a lock available on the product's door, keep the key out of children's reach.



1.4 Electrical Safety

- The product shall not be plugged into the outlet during installation, maintenance, cleaning, repair, and transportation operations.
- If the power cable is damaged, it must be replaced by the person sent by the manufacturer, authorized service provider or the importer to prevent any potential danger.
- Do not tuck the power cable under the product or to the rear of the product. Do not put heavy items on the power cable. The power cable should not be bent, crushed, and come into contact with any heat source.
- Use an original cable only. Do not use cut or damaged cables.
- Do not use an extension cord, multi-plug or adaptor to operate your product.
- Portable multi-plugs or portable power supplies may overheat and cause fire. Thus, do not have a multi-plug, portable power sources behind or in the vicinity of the product.

- Before plugging the product into the power source, please remove the power cable from the condenser hook (if available) during the installation.
- The user should not be able to reach the electrical parts after installation.
- Do not plug the product's power cord in a loose or damaged power outlet. These types of connections may overheat and cause fire.
- The plug shall be easily accessible. If this is not possible, a mechanism that meets the electrical legislation and that disconnects all terminals from the mains (fuse, switch, main switch, etc.) shall be available on the electrical installation.
- The product must not be operated with an external switching device such as a timer, or a remote controlled system.
- Do not use the product when your feet are bare or your body is wet.
- Do not touch the plug with wet hands.
- When unplugging the appliance, don't hold the power cable, but the plug.
- Make sure that the plug is not wet, dirty or dusty.

- Do not ever connect your product to power saving devices. These systems are harmful for the product.

1.5 Handling Safety

- Make sure to unplug the appliance before carrying the product.
- This product is heavy, do not handle it by yourself. Injuries may occur if the product falls on you. Do not bump into places or drop the product while transporting it.
- Always close the doors and do not hold the product by its doors while transporting it.
- Be careful not to damage the cooling system and the pipes while handling the product. Do not operate the product if the pipes are damaged, and contact an authorized service.

1.6 Installation Safety

- To prepare the product for use, see the information in the user and installation manual and make sure the electric and water utilities are as required. If not, call a qualified electrician and plumber to arrange the utilities as necessary.
- **Failure to do so may result in electric shock, fire, problems with the product, or injury.**

- Before starting the installation, switch off the fuse to de-energise the power line to which the product is connected.
- The product should be installed by two or more people. Use protective gloves while removing the product from the packaging and installation.
- This product is designed for use at a maximum altitude of 2000 metres above sea level.
- Keep children away from installation area.
- Check for any damage on the product before installing it. Do not have the product installed if it is damaged.
- Always use personal protective equipment (gloves, etc.) during product installation, maintenance and repair. Risk of injury.
- Do not install or leave the product in places where it may be exposed to external ambient temperatures.
- Place the product on a clean, level and hard surface and balance it with the adjustable legs (by rotating the front feet to the right or left). Otherwise, the refrigerator may tip over and cause injuries.
- Proceed with care to prevent causing any damage to the floors (tiling etc.) while moving the product. Install the product on a floor, or provide sufficient support depending on the size, weight and the use-case of the product. Ensure that the product is not near a heat source, and all four feet are stable and leaning against the floor. Install the product as necessary, and ensure that it is horizontal, using a bubble level. To ensure the complete efficiency of the refrigerant circuit, wait for at least two hours before operating the product.
- The product shall be installed in a dry and ventilated environment. Do not keep carpets, rugs or similar covers under the product. This may cause risk of fire as a result of inadequate ventilation!
- Do not block or cover ventilation holes. Otherwise, power consumption increases and your product may be damaged.
- Leave sufficient space by the sides and above to ensure adequate ventilation. The gap between the back panel and the wall behind the product must be a minimum of 50mm in order to prevent hot surfaces. Reducing this distance may increase the energy consumption of product.

- When placing the product, make sure that the supply cable is not damaged or pinched.
- The product must not be connected to supply systems and power sources which may cause sudden voltage changes (i.e. a portable solar-energy power source). Otherwise, damage to your product may occur as a result of the abrupt voltage fluctuations!
- The more refrigerant a refrigerator contains, the bigger its installation room shall be. In very small rooms, a flammable gas-air mixture may occur in case of a gas leak in the cooling system. At least 1 m³ of volume is required for each 8 grams of refrigerant. The amount of the refrigerant available in your product is specified in the Type Label.
- The product must never be placed in such a way that power cables, the metal hose of the gas stove, metal gas or water pipes come into contact with the product's rear wall (or the condenser).
- The installation place of the product must not be exposed to direct sunlight and it shall not be in the vicinity of a heat source such as stoves, radiators, etc. If you cannot prevent installation of the product in the vicinity of a heat source, use a suitable insulation plate and make sure the minimum distance to the heat source is as specified below:
 - At least 30 cm away from heat sources such as stoves, ovens, heating units and heaters, etc.,
 - And at least 5 cm away from electrical ovens.
- Your product has the protection class of I.
- Plug the product in a grounded socket that conforms with the Voltage, Current and Frequency values specified in the type label. The socket must have a 10A – 16A fuse. Our firm will not assume responsibility for any damages due to usage without earthing and without power connection in compliance with local and national regulations.
- The product's power cable must be unplugged during installation. Otherwise, risk of electric shock and injury may occur!
- Do not plug the product to loose, broken, dirty, greasy sockets or sockets that have come out of their seats or sockets with a risk of water

contact. These types of connections may overheat and cause fire.

- Place the power cable and hoses (if any) of the product so that they shall not cause a risk of tripping over.
- Penetration of humidity and liquid to live parts or to the power cord may cause short circuit. Thus, do not use the product in humid environments or in areas where water may splash (e.g. garage, laundry room, etc.) If the refrigerator is wet by water, unplug it and contact an authorized service.
- Do not ever connect your refrigerator to power saving devices. These systems are harmful for the product.
- There is a risk of contact with electrical parts when removing the electronic board cover and the compressor rear cover (if fitted). Do not remove the electronic board cover and the compressor rear cover (if fitted). There is a risk of electrocution!

1.7 Operational Safety

- Do not ever use chemical solvents on the product. These materials contain an explosion risk.
- In case of a failure of the product, unplug it (or de-energise the fuse to which it is connected), and do not operate until it is repaired by the authorized service. There is a risk of electric shock!
- Do not place flames (lighted candle, cigarette, etc.) or heat sources (iron, hob, oven, etc.) on or near the product. Do not place flammable/explosive materials near the product...
- Do not get on the product. Risk of falling and injury!
- Do not cause damage to the pipes of the cooling system using sharp and piercing tools. The refrigerant that sprays out in case of puncturing the gas pipes, pipe extensions or upper surface coatings may cause irritation of skin and injury to the eyes.
- Do not intervene in or damage the coolant circuit Risk of explosion.

- Do not place and operate electrical appliances inside the refrigerator/freezer unless it is advised by the manufacturer.
- Do not use any procedures other than those recommended by the manufacturer to speed up defrosting.
- Take due care not to jam any parts of your hands or your body to the moving parts inside the product. Be careful to prevent jamming of your fingers between the refrigerator and its door. Be careful while opening or closing the door if there are children around.
- Do not put ice cream, ice cubes or frozen food to your mouth as soon as you take them out of the freezer. Risk of frostbite!
- Do not touch the inner walls, metal parts of the freezer or food kept inside the freezer with wet hands. Risk of frostbite!
- Do not place soda cans or cans and bottles that contain fluids that may be frozen to the freezer compartment. Cans or bottles may explode. Risk of injury and material damage!
- Do not use or place materials sensitive against temperature such as flammable sprays, flammable objects, dry ice or other chemical agents in the vicinity of the refrigerator. Risk of fire and explosion!
- Do not store explosive materials such as aerosol cans with flammable materials inside the product.
- Do not place cans containing fluids over the product an open state. Splashing of water on an electrical part may cause an electric shock or a fire.
- Due to risk of breaking, do not store glass containers with liquid inside in the freezer compartment.
- This product is not intended for storage and cooling of medicines, blood plasma, laboratory preparations or similar materials and products that are subject to the Medical Products Directive.
- If the product is used against its intended purpose, it may cause damage to or deterioration of the products stored inside.
- If your refrigerator is equipped with blue light, do not look at this light with optical devices. Do not stare directly at UV LED light for a long time. Ultraviolet rays may cause eye strain.
- Do not fill the product with more contents than its capacity. Do not use any proced-

ures other than those recommended by the manufacturer to speed up defrosting. Injuries or damages may occur if the contents of the refrigerator fall when the door is opened. Similar problems may also occur when an object is placed over the product.

- Ensure that you have removed any ice or water that may have fallen to the floor to prevent injuries.
 - Change the locations of the racks/bottle racks on the door of your refrigerator only when the racks are empty. Danger of injury!
 - Do not place objects that may fall/tip over on the product. These objects may fall while opening or closing the door and cause injuries and/or material damages.
 - Do not hit or exert excessive pressure on glass surfaces. Broken glass may cause injuries and/or material damages.
 - For products designed to use an air filter inside an accessible fan cover, the filter must always be in position when the refrigerator is in function.
 - Do not block out the fan (if available) with food.
- Damaged gaskets should be replaced as soon as possible.
 - Your product may have special compartments (Fresh Food Compartment, Zero Degrees Compartment etc.) Unless otherwise stated in the relevant manual of the product, these compartments can be removed, and the product can be used with the same performance.
 - The cooling system in your product contains R600a refrigerant. The refrigerant type used in the product is specified in the type label. This gas is flammable. Therefore, be careful not to damage the cooling system and the pipes while operating the product. In case of damage to the pipes;
 1. Do not touch the product or the power cable.
 2. Keep the product away from potential sources of fire that may cause the product to catch fire.
 3. Ventilate the area where the product is placed. Do not use a fan.
 4. Contact Authorized Service.Before disposing of old products that shall not be used any more:
 1. Unplug the power cord from the mains socket.

2. Cut the power cable and remove it from the appliance together with the plug.
 3. Do not remove the racks and drawers from the product to prevent children from getting inside the appliance.
 4. Remove the doors.
 5. Store the product so that it shall not be tipped over.
 6. Do not allow children to play with the scrapped product.
 7. If the product is damaged and you observe gas leak, please stay away from the gas. Gas may cause frostbite if it contacts your skin.
- Do not dispose of the product by throwing it into fire. Risk of explosion.
 - If there is a lock available on the product's door, keep the key out of children's reach.

For Products with Water Dispenser / Icematic

- Use only drinking water. Do not fill the water tank with fruit juice, milk, fizzy beverages, alcoholic beverages or any other liquids incompatible for use in the water dispenser. This may cause risk to your health and safety.
 - Do not allow the children to play with the water dispenser or icematic to prevent accidents and injuries.
- Do not insert your hands, fingers or other objects inside the hole of the water dispenser, ice channel or inside the container of the icematic. This may cause injuries or material damages.
 - The hose sets supplied with the product shall be used. Do not use the old hose sets. Do not extend the hoses!
 - Always connect your product to cold water inlet. Do not perform installation on the hot water inlet. The pressure for the cold water inlet shall be 90 P_{Si} (620 kPa – 6.2 bar) maximum. If your water pressure exceeds 80P_{Si} (550 kPa – 5.5 bar) or has a water impact effect, use a pressure limiting valve on your mains system. Ask help from professional plumbers if you do not know how to control your water pressure.
 - High pressure may cause damage to the hose connections and pose a risk of flooding.
 - Take required precautions against the risk of freezing of hoses. The operating water temperature interval shall be 0.6°C (33°F) minimum and 38°C (100°F) maximum. There is a risk of flooding if the hose is cracked/perforated.



1.8 Food Storage Safety

Please pay attention to the following warnings to avoid food spoilage:

- Leaving the doors open for a long time may cause the temperature inside the product to rise.
- Regularly clean the accessible drainage systems in contact with food.
- Clean the water tanks that have not been used for 48 hours and mains-fed water systems that have not been used for more than 5 days.
- Store raw meat and fish products in appropriate compartments within the product. Thus, it does not drip on or come into contact with other foods.
- Two-star freezer compartments are used for storing pre-filled foods, making and storing ice and ice cream.
- One, two and three-star compartments are not appropriate for freezing fresh food.
- If the cooling product has been left empty for a long time, turn off the product, defrost, clean, and dry the product in order to protect the housing of the product.

- After the foods are placed, check if the compartment hatches, and especially the freezer door, are properly closed.
- Use the refrigerator compartment for storing fresh foods, and the freezer compartment for storing frozen goods, freezing fresh foods and preparing ice cubes.
- Do not store foods without properly sealing them in the refrigerator and the freezer compartments, to prevent direct contact with the inner surfaces.



1.9 Maintenance and Cleaning Safety

- Unplug the refrigerator or de-energise the fuse before cleaning it or starting to perform maintenance.
- Do not pull by the door or door handle if you are going to move the product for cleaning purposes. The door may cause injuries if the handle is pulled too hard.
- Do not place hands, feet or metal objects under or behind your product. Jamming may occur or any sharp edge may cause personal injuries.

- Do not wash the inside or outside of the product with a pressure washer, steam, spray water or pouring water. Risk of electric shock and fire.
- When cleaning the product, do not use sharp and abrasive tools or household cleaning agents, detergent, gas, gasoline, thinner, alcohol, varnish, and similar substances. Use only cleaning and maintenance agents that are not harmful for food inside the product.
- Do not use paper towels, kitchen sponges or other hard cleaning materials.
- Do not ever use steam or steamed cleaning materials for cleaning the product and thawing the ice inside it. Steam contacts the live areas in your refrigerator and causes short circuit or electric shock.
- Do not use any mechanical tools or any other tools than the recommendations of the manufacturer to speed up the thawing operation.
- Take care to keep water away from the ventilation holes, electronic circuits or lighting of the product. Otherwise, risk of fire or electric shock may occur.
- Use a clean, dry cloth to wipe the dust or foreign material on the tips of the plugs. Do not use a wet or damp piece of cloth to clean the plug. Otherwise, risk of fire or electric shock may occur.

1.10 Lighting

Contact an authorized service when you shall replace the LED / bulb using for lighting.

1.11 Disposal of the Old Product

When disposing of your old product follow the instructions below:

- To prevent children from accidentally locking themselves into the product, if there is door lock, disable it.
- Splash of coolant is harmful to the eyes. Do not damage any part of the cooling system while disposing of the product.
- It may be fatal if the compressor oil is swallowed or if it penetrates the respiratory tract.
- Cooling system of your product includes R600a gas as specified in the type label. This gas is flammable. Do not dispose of the product by throwing it into fire. Risk of explosion!

- C -Pentane is used as a blowing agent in insulation foam and it is a flammable substance. Do not dispose of the product by throwing it into fire.

1.12 HomeWhiz

- Follow the safety warnings even if you are away from the product while operating the product via HomeWhiz app. Also, pay attention to the warnings in the app.

1.13 Technical Information About Bluetooth + Wi-fi

Frequency Band:	2.4GHz (Wi-fi or bluetooth function)
Max. Transferring Power:	< 100mW (Wi-fi or bluetooth function)
Software Details:	Quartz_WiFi.XXX

SIMPLIFIED EU DECLARATION OF CONFORMITY:

Hereby, Arçelik A.Ş. declares that the radio equipment is in compliance with Directive 2014/53/EU.

The full text of the EU declaration of conformity is available at the following internet address: parts-selfservice.europeanappliances.com

This product collects and transmits usage data when connected to the internet (e.g. temperature settings, usage duration, error codes **etc.**). In accordance with the EU Data Act (Regulation EU 2023/2854), you have the right to access and manage this data.

For details on what data is collected, how it is used, and how to access it, please visit:

www.homewhiz.com/eu-data-act-policy

Frequency Band:	2.4GHz (Wi-fi or bluetooth function)
Max. Transferring Power:	< 100mW (Wi-fi or bluetooth function)
Software Details:	Quartz_WiFi.XXX

UKCA Declaration of Conformity:

Arçelik A.Ş. states that this product is in compliance with 2017 Radio Equipment Regulation (2017).

The entire UKCA declaration of conformity is available on the following website: Hotpoint

2 Environmental Instructions

2.1 Compliance with the WEEE Directive and Disposing of the Waste Product



This product complies with EU WEEE Directive (2012/19/EU). This product bears a classification symbol for waste electrical and electronic equipment (WEEE).

This symbol indicates that this product shall not be disposed with other household wastes at the end of its service life. Used device must be returned to official collection point for recycling of electrical and electronic devices. To find these collection systems please contact to your local authorities or retailer where the product was purchased. Each household performs important role in recovering and recycling of old appliance. Appropriate disposal of used appliance helps prevent potential negative consequences for the environment and human health.

Compliance with RoHS Directive

The product you have purchased complies with EU RoHS Directive (2011/65/EU). It does not contain harmful and prohibited materials specified in the Directive.



Package information

Packaging materials of the product are manufactured from recyclable materials in accordance with our National Environment Regulations. Do not dispose of the packaging materials together with the domestic or other wastes. Take them to the packaging material collection points designated by the local authorities.



Conformity with standards and test information / Declaration of EC conformity

Development, manufacture and sales stages of this product conform to the safety rules in all relevant guidelines of the European Community. 2014/35/EU, 2014/30/EU, 93/68/EC, IEC 60436/DIN 44990, EN 50242

3 Your refrigerator

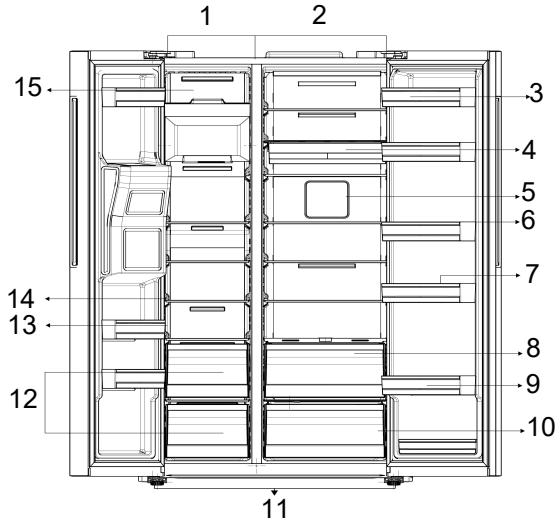

- | | |
|---|---------------------------------------|
| 1 Freezer compartment | 2 Chiller compartment |
| 3 *Chiller compartment door rack | 4 *Sliding tray |
| 5 *Fan | 6 *Chiller compartment glass shelves |
| 7 *Eggy compartment | 8 *Zero degree zone |
| 9 **Refrigerator compartment door shelves** | 10 *Crisper |
| 11 Adjustable feet | 12 *Freezer compartment drawers |
| 13 *Freezer compartment door racks | 14 *Freezer compartment glass shelves |
| 15 *Ice maker | |

***Optional:** The figures in this instruction manual are schematic and may not be exactly the same as your product. If the parts

you purchased are not available with your product, these figures are applicable to other models.

4 Installation

Right place for installation

Read the "Safety Instructions" first!

Contact the Authorized Service for the product's installation. To prepare the product for installation, see the information

in the user manual and make sure the electric and water utilities are as required. If not, call an electrician and plumber to arrange the utilities as necessary.

- Damaged power cable must be replaced by Authorized Service.
- When placing two coolers in adjacent position, leave at least 4 cm distance between the two units.
- Keep the product out of direct sunlight and in a dry place.
- The distance between the product and the side walls should be 3 mm and the distance between the product and the rear wall should be 35 mm. (ElegantFit)
- If the door span is too narrow for the product to pass, remove the door and turn the product sideways; if this does not work, contact the authorized service.
- Place the product on a flat surface to avoid vibration
- Place the product at least 30 cm away from the heater, stove and similar sources of heat and at least 5 cm away from electric ovens.
- Do not expose the product to direct sunlight or keep in damp environments.
- Before transport or use, never open the control board cover on the product. Risk of electric shock and fire!
- Our firm will not assume responsibility for any damages due to usage without earthing and without power connection in compliance with national regulations.
- The power cable plug must be easily accessible after installation.

Hot surface warning!

The side walls of your product are equipped with cooler pipes to enhance the cooling system. High pressure fluid may flow through these surfaces, and cause hot surfaces on the side walls. This is normal and it does not require servicing. Be careful when you contact these areas.

Attaching the plastic wedges

Use the plastic wedges provided with the product to maintain sufficient space for air circulation between the product and the wall.

- Remove the screws on the product and mount the screws provided with the wedges.
- Attach 2 plastic wedges on the ventilation cover as shown in the figure.

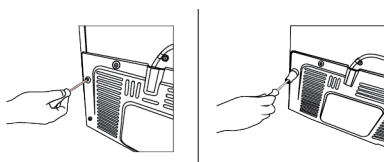

Adjusting the Legs

If the product is not in balanced position, adjust the front adjustable stands by rotating right or left.

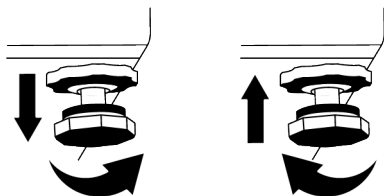

For adjusting the doors vertically,

Loosen the fixing nut at the bottom. Screw adjusting nut (CW/CCW) according to the position of the door. Tighten the fixing nut bolt for the final position.

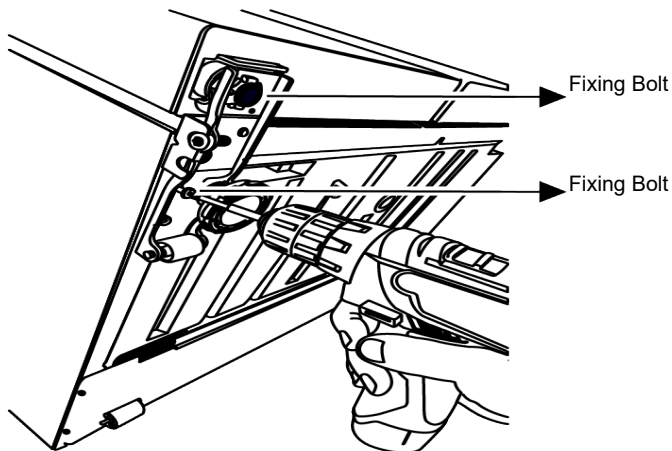

For adjusting the doors horizontally,
 Loosen the fixing screw at the bottom
 Loosen the fixing nut at the top. Screw the
 adjusting bolt (CW/CCW) on the side ac-

ording to the position of the door. Tighten
 the fixing nut on the top for the final posi-
 tion Tighten the fixing screw at the bottom

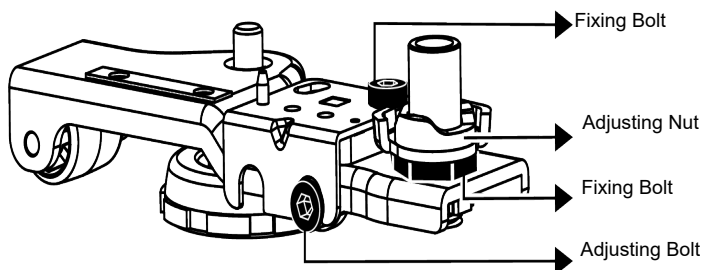

Fix the upper hinge assembly with 3 screws.
Install the hinge cover after the sockets are installed.
Secure the hinge cover with two screws.

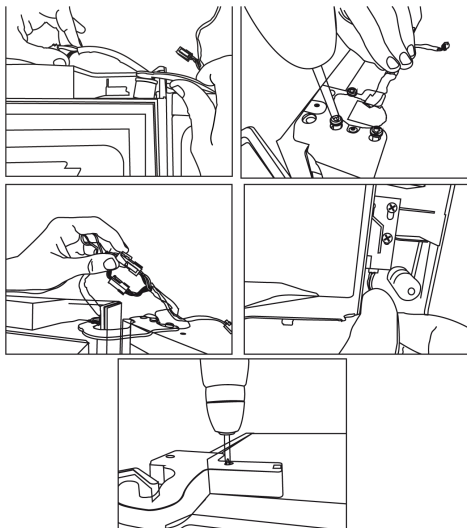

5 Preparation

Read the "Safety Instructions" first!

5.1 What To Do For Energy Saving

- When loading the food, leave enough space inside the refrigerator to allow sufficient air circulation for cooling.
- Since hot and humid air will not directly penetrate into your product when the doors are not opened, your product will optimize itself in conditions sufficient to protect your food. Under these circumstances, functions and components such as compressor, fan, heater, defrost, lighting, display and so on will operate according to the needs by consuming minimum energy.
- In case that multiple options are present, glass shelves must be placed so that the air outlets at the rear wall are not blocked and preferably, in a way that air outlets remain below the glass shelf. This combination may help improving air distribution and energy efficiency.
- Using the below drawer when storing is strongly recommended.
- For optimum performance, Quick Freezing can be used (if available), 24 hours prior to placing fresh foods in the freezer.

- In most cases, 24 hours is enough for the Quick Freezing function after fresh foods are placed in the freezer. After some time, Quick Freezing function will deactivate automatically.
- When freezing a small amount of food, Quick Freezing function can be deactivated after some time to ensure energy saving.
- Store food in the cooler or chill compartment according to proper storage conditions to save energy.

5.2 First Use

Before using your product make sure the necessary preparations are made in line with the instructions in "Safety Instructions" and "Installation" sections.

- Wait for at least 2 hours before operating the product, to ensure the complete efficiency of refrigeration.
- Keep the product running without placing any food inside for 6 hours and the product door should be kept as closed as possible.

- The temperature change caused by opening and closing of the door while using the product may normally lead to condensation on door/body shelves and glassware placed in the product.
- A sound will be heard when the compressor is engaged. It is normal for the product to make noise even if the compressor is not running, as fluid and gas may be compressed in the cooling system.
- It is normal for the front edges of the product to be warm. These areas are designed to warm up in order to prevent condensation
- For some models, indicator panel turns off automatically 1 minute after the door closes. It will be reactivated when the door is opened or any button is pressed.

6 Operating the Product

Read the "Safety Instructions" first!

- The product shall be used for storing food only.
- Turn off the water valve if you will be away from home (e.g. at vacation) and you will not be using the Icematic or the water dispenser for a long period of time. Otherwise, water leaks may occur.

5.3 Climate Class and Definitions

Please refer to the Climate Class on the rating plate of your device. One of the following information is applicable to your device according to the Climate Class.

- **SN:** Long Term Temperate Climate: This cooling device is designed for use at ambient temperatures between 10 °C and 32 °C.
- **N:** Temperate Climate: This cooling device is designed for use at ambient temperatures between 16°C and 32 °C.
- **ST:** Subtropical Climate: This cooling device is designed for use at ambient temperatures between 16°C and 38°C.
- **T:** Tropical Climate: This cooling device is designed for use at ambient temperatures between 16°C and 43°C.

Unplugging the Product

- Remove the food to prevent odours,
- Wait for the ice to melt, clean the interior and let it dry, leave the doors open to avoid damaging the inner body plastics.

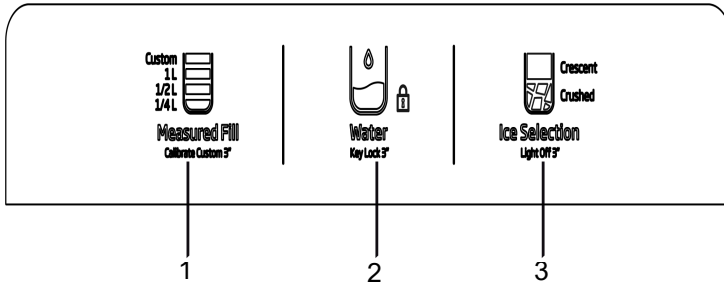

- 1 Water Volume Selection Key
- 3 Ice Cube Selection Key

- 2 Water Selection Key

Read the “Safety Instructions” first! The audio and visual functions on the instrument panel help you use the product. *Optional: The functions shown are optional, the functions on the display panel of your product may differ in terms of shape and location.

1. Water Quantity Selection Button

This button allows the user to adjust the amount of water. A short press of the button toggles between 1/4 L, 1/2 L, and 1 L. **Custom** (custom) option is used to automatically dispense a predetermined amount of water. When the user holds this button for 3 seconds, the current amount of water **Custom** is recorded as the amount.

After that, **Custom** Each time the trigger is pressed while the LED is selected, the user will receive the preset amount of water.

2. Water Selection Button

This button activates the water flow from the trigger. Once the user selects this mode, the water flow continues as long as the trigger is pressed. You can also lock the screen by holding down this button for 3 seconds.

Notes: This lock only locks the on-screen buttons; the trigger watering process is not affected.

3. Ice Cube Selection Button

With this button, the user can switch to ice making mode. Each short press on the button **Crescent** (cube) and **Crushed** (Cracked)

ice options are switched. You can also turn off the trigger light by holding this button for 3 seconds.

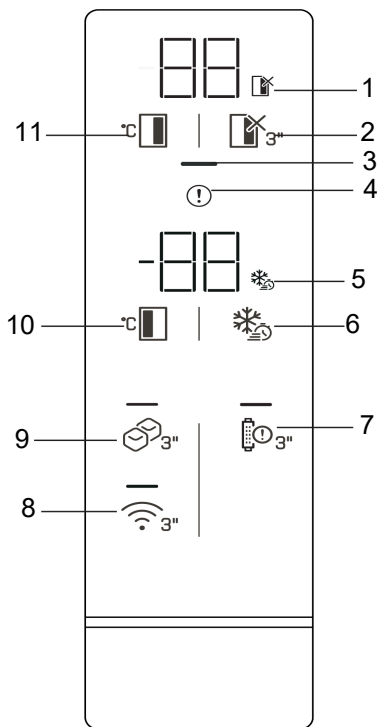

- | | |
|---|---|
| 1 *Refrigerator compartment closing (Holiday) function icon | 2 *Refrigerator compartment shutdown (Holiday) button |
| 3 *Energy saving indicator | 4 Error status indicator |
| 5 *Quick freeze function icon | 6 *Quick freeze button |
| 7 *Filter reset button | 8 *Wireless button |
| 9 *Ice maker on/off switch | 10 Freezer compartment temperature setting knob |
| 11 Refrigerator compartment temperature adjustment button | |

Read the "Safety Instructions" first!
The audio and visual functions on the instrument panel help you use the product.

*Optional: The functions shown are optional, the functions on the display panel of your product may differ in terms of shape and location.

1. Refrigerator Compartment Shutdown (Holiday) Function Icon

The relevant icon, the holiday symbol, illuminates when Refrigerator Compartment Shutdown is activated. The Refrigerator Compartment temperature display shows "--" and the Refrigerator Compartment does not perform active cooling.

2. Refrigerator Compartment Shutdown (Holiday) Button

To activate the vacation function, press the button for 3 seconds. Vacation mode is activated and the vacation icon lights up. The refrigerator compartment temperature indicator will show "--" and the refrigerator compartment will not perform active cooling.

3. Energy Saving (Display Off) Indicator

When the product's doors are not being opened or closed, energy saving mode is automatically activated and the energy saving symbol will light up (a horizontal symbol will appear). Energy saving function.

When activated, all icons on the screen except the energy saving icon turn off. If any button is pressed or a door is opened while the energy saving function is active, the function is deactivated and the icons on the screen return to normal. The energy saving function is a factory default function and cannot be deactivated.

*Wireless Connection Settings Reset

Key {116}+

To reset the wireless connection settings, press and hold the Quick Freeze ({118}) and Wireless () buttons simultaneously for 3 seconds.

When wireless settings are reset/restored to factory defaults, all user information previously used for setup is forgotten on the product.

*Celsius/Fahrenheit Conversion {120} +



Pressing the Refrigerator Compartment Temperature Adjustment Button ({122}) and the Refrigerator Compartment Shut-

down (Holiday) Button () simultaneously for 3 seconds will switch the temperature display between Celsius and Fahrenheit.

*Sabbath Mode {124} +

To activate/deactivate Sabbath mode, press the Freezer Compartment Temperature Setting Button () and the Quick

Freeze () button simultaneously for 3 seconds. When Sabbath mode is activated, the display buttons, door opening alarm, or lights will not function.

4. Error Status Indicator

This indicator will be active when the refrigerator is not cooling sufficiently or a sensor error occurs. The letter "E" will appear on the freezer compartment temperature indicator, and numbers such as 1, 2, and 3 will appear on the refrigerator compartment temperature indicator.

These numbers on the display inform the service about the error that has occurred. When you load hot food into the freezer compartment or leave the door open for an extended period, an exclamation point may illuminate temporarily. This is not a malfunction; the warning will clear when the food cools or any button is pressed.

5. Quick Freeze Function Icon

The corresponding icon lights up when the fast freezing function is activated.

6. Quick Freeze Button

When the fast freeze button is pressed, the fast freeze icon illuminates and the fast freeze function is activated. The freezer compartment temperature is set to -27°C. To cancel the function, press the button again. The fast freeze function automatically cancels itself. If you want to freeze large quantities of fresh food, press the fast freeze button before placing the food in the freezer compartment.

7. Filter Reset Button

The refrigerator's water inlet filter should be replaced at regular intervals. Your refrigerator automatically calculates this time. When the filter's lifespan is over, the LED on

the filter replacement warning button will light up. After replacing the filter, press and hold the button for 3 seconds to turn off the filter replacement warning LED.

8. Wireless Button

When you hold down the button for 3 seconds, the wireless connection icon on the display will flash slowly (0.5-second intervals). This initiates the initial registration of the home network to the product. Once the wireless connection is established with the product, the wireless connection icon will remain lit.

After the initial setup is complete, you can activate/deactivate the connection by pressing this button. The wireless connection icon will flash rapidly (at 0.2-second intervals) until the connection is established. Once the connection is active, the wireless network icon will remain lit. If the connection is not established for an extended period, check your connection settings and refer to the "Troubleshooting" section of the user manual. The HomeWhiz app must be used for wireless connection. Setup steps are explained through the app during setup.

You can access the app by scanning the QR code on the HomeWhiz label on the product. The app is available in the App

Store for iOS devices and the Play Store for Android devices. For more information, visit <https://www.homewhiz.com/>

9. Ice Maker On/Off Button

Pressing this button for 3 seconds activates ice making and the LED above the button illuminates. Pressing the button again for 3 seconds cancels the ice making process, allowing you to use previously prepared ice cubes even if the function is canceled.

10. Freezer Compartment Temperature Adjustment Button

The temperature setting for the freezer compartment is made. By pressing the button, the freezer compartment temperature can be set to -18, -19, -20, -21, -22, -23, -24 Celsius.

11. Refrigerator Compartment Temperature Adjustment Button

The temperature setting for the refrigerator compartment is made. By pressing the button, the refrigerator compartment temperature can be set to 8, 7, 6, 5, 4, 3, 2 and 1 °C.

*

The temperature can be set between 1-8°C for the chiller compartment and between -24 and -15°C for the freezer compartment. Adjustable temperature values may vary provided that they are within these ranges according to product specifications.

8 Use of Your Appliance

8.1 Food Storage in Freezer, Refrigerator and Chill Compartment

Storing food in the freezer compartment

- You can cool faster by activating the Fast Freeze function 4-6 hours before freezing.
- Bring hot foods to room temperature before placing them in the freezer compartment.
- Foods to be frozen should be divided into portions large enough to be consumed each time and frozen in separate packages.
- It is recommended that you wrap food before putting it in the freezer.
- To prevent the storage period from exceeding, write the freezing date, duration and name of the food on the package according to the storage periods of different foods.

- Eat thawed foods quickly. Thawed foods cannot be refrozen unless cooked. It is not safe to consume fresh foods that have been thawed and refrozen without cooking.
- When freezing fresh food, do not allow it to come into contact with already frozen food. Otherwise, the frozen food will thaw.

Storing frozen foods

- When storing food, comply with the times specified in these instructions.
- To preserve the quality of food, try to keep the time between purchase and storage as short as possible.
- Buy frozen foods stored at -18°C or below.
- Avoid buying foods with ice, etc., in their packaging. This means the product may have partially thawed and refrozen. Temperature affects food quality.
- Do not exceed the storage time recommended by the food manufacturer. Remove only the amount of food you need from the freezer.
- Except in cases of extreme environmental conditions, if your product is set to the set values specified in the recommended set value table, food will remain fresh for longer in both the fresh food compartment and the freezer compartment.
- If the fresh food compartment is set to a lower temperature, fresh fruits and vegetables may partially freeze.

Quick freezing

1. Activate the quick freezing function 24 hours before placing your fresh foods.
2. After 24 hours after pressing the button, place your food that you want to freeze in the third or fourth shelves with higher freezing capacity.
3. Once the quick freezing function is activated, it is automatically cancelled after a period of time.

Deep freezer information

According to IEC 62552 standards, for every 100 liters of freezer compartment volume, the product must be able to freeze 4.5 kg of food at 25°C room temperature in 24 hours at -18°C or lower temperatures.

Long-term preservation of food is only possible at temperatures of -18°C and below.

You can preserve the freshness of food items (in the deep freezer at temperatures of -18°C and below) for months.

Food items to be frozen should not be allowed to come into contact with previously frozen foods to prevent them from partially thawing.

To extend the storage life of frozen vegetables, boil them and drain them. After draining, place them in airtight containers and place them in the freezer. Bananas, tomatoes, lettuce, celery, hard-boiled eggs, potatoes, etc., are not suitable for freezing. Freezing these foods will only negatively affect their nutritional value and eating quality. There is no risk of spoilage that poses a health risk.

Placement of foods

Freezer compartment shelves: Various frozen foods such as meat, fish, ice cream, vegetables, etc.

Refrigerator compartment shelves: Food in pots, covered dishes and covered containers, eggs (in a covered container)

Refrigerator compartment door shelves:

Small, packaged food or beverages

Vegetable bin: Vegetables and fruits

Fresh food compartment: Deli products (breakfast items, meat products to be consumed quickly)

Storing Food in the Refrigerator Compartment

- If the compartment door is opened and closed frequently and left open for long periods of time, the compartment temperatures will increase significantly, which may reduce the life of the food and cause the food to spoil.

- To avoid any change in odor or taste, foods should be stored in closed containers.
- Do not store too much food in your product. To achieve better and more even cooling, place the food items spaced apart so that cold air can circulate between them.
- Leave space between the food and the inside wall to allow air flow. Food placed against the back wall can freeze.
- Allow cooked, hot food to cool to room temperature before placing it in the appliance. Then, you can place the lukewarm food on the lower shelves of your appliance. Do not place lukewarm food near easily perishable foods.
- Defrost your frozen food in the fresh food compartment. This way, you can use the frozen food to cool the fresh food compartment and save energy.
- Storing unripe tropical fruits (mango, various types of melon, papaya, banana, pineapple) in your produce can accelerate the ripening process. This is not recommended as it will result in a shorter shelf life.
- Onions, garlic, ginger, and other root vegetables should be stored in a dark, cool room, not in the produce itself.
- If you notice that any food inside the product has spoiled, discard that food and clean any accessories that came into contact with it.
- To quickly cool large pot dishes like soups and stews, you can divide them into shallow containers and place them in your container.
- Do not place unwrapped foods near eggs.
- Keep fruits and vegetables separate from each other and store each type together (e.g. apples with apples, carrots with carrots).
- Remove the greens from the plastic bag, wrap them in a paper towel or dishcloth, and then add them to the dish. If you wash these types of foods before adding them to the dish, remember to dry them afterwards.
- You can create a humid environment and allow air flow by storing fruits and vegetables that are prone to drying in perforated or open-mouthed plastic bags.
- Except in cases of extreme environmental conditions, if your product is set to the set values specified (in the recommended set value table), the food will remain fresh for longer in both the fresh food compartment and the freezer compartment.
- Do not store cold-sensitive vegetables such as leafy greens, tomatoes, and cucumbers in the cold compartment. If the cold compartment must be used to store vegetables, ensure that your refrigerator's control panel is set to 5°C or warmer.

Food Storage in the Chill Compartment

In the cold compartment, the temperature of the food being stored can vary between +3°C and -3°C. Temperatures may drop below 0°C in the chill compartment, therefore it is not suitable for storing fresh fruits/vegetables. If you need to store fresh food in the chill compartment, make sure you set the refrigerator setting to 5°C or warmer.

Store different foods in different places according to their characteristics.

Food	Location
Egg	Door shelf
Dairy products (butter, cheese)	Zero degree (breakfast) compartment, if available
Fruits, vegetables and greens	Fruit and vegetable compartment, vegetable bin or EverFresh+ compartment (if available)

Food	Location
Fresh meat, poultry, fish, sausage derivatives Cooked foods	Zero degree (breakfast) compartment, if available
Ready-to-eat foods, packaged goods, canned goods and pickles	Top shelves or door shelf
Beverages, bottles, condiments and snacks	Door shelf

Recommended set values table

Freezer Compartment Setting	Fridge Compartment Setting	Remarks
-22°C	4°C	This is the default, recommended setting. This setting is recommended if ambient temperature is below 30°C.
-22°C or colder	4°C	These settings are recommended for ambient temperatures exceeding 30°C.
Quick Freeze	4°C	Use when you want to freeze your food in a short time. When the process ends, the product's settings will return to previous position.
-18°C or colder	2°C	Use these settings if you believe the cooler compartment is not cold enough due to ambient temperature or frequently opening the door.

8.2 Replacing the Illumination Lamp

Call the Authorized Service when the Bulb/LED used for lighting in your refrigerator will be replaced.

Lamp(s) used in this appliance cannot be used for house lighting. Intended use of this lamp is to help the user place food into the refrigerator / freezer safely and comfortably.

8.3 Door Open Alert

The door open alert system of your refrigerator may differ depending on the model.

Version 1;

If the door of the product remains open for a certain time (between 60 s and 120 s), an audio warning signal sounds; depending on the product model, a visual warning signal (light flash) can also be displayed. If you close the door of the device or press a button on the screen of the device, if any, the warning sound will stop.

Version 2;

If the door of the device remains open for a certain period of time (between 60 s and 120 s), the door open alert is sounded. The door open alert is sounded gradually. First, an audible warning starts to sound. After 4 minutes, if the door is still not closed, a visual warning (lighting flash) is activated. The door open alert will be delayed for a certain period of time (between 60 s and 120 s) when any key on the product screen, if any, is pressed. Then the process will start again. When the device door is closed, the door open alert will be cancelled.

8.4 Active Check

Active Check is a smart control feature that constantly monitors your product's status using artificial intelligence, identifying potential problems before they even occur and notifying you. This ensures your product's performance is always secure and prevents unexpected malfunctions. For Active Check to work, your product must be connected to the internet via the HomeWhiz app.

9 Product Features

9.1 The ice storage area

Ice Container

Ice bucket allows you to take ice easily from the refrigerator.

Using the ice bucket

1. Take the ice bucket out of the freezer compartment.
2. Fill the ice bucket with water.

3. Place the ice bucket into the freezer compartment. The ice will be ready after approximately two hours.
4. Take the ice bucket from the freezer compartment and bend in slightly over the holder that you are going to serve. Ice will easily pour into the serving holder.

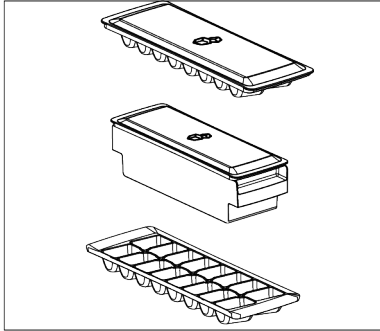

9.2 Dairy Products Cold Storage Area

Cold Storage Compartment

The Cold Storage Compartment provides a lower temperature inside the product. Use this compartment to store deli products (salami, sausages, dairy products, etc.) or meat, chicken, and fish products that need to be kept at a lower temperature for immediate consumption. Do not store fruits and vegetables in this compartment.

9.3 Artificial Intelligence (AI) Technology



Artificial Intelligence Feature

Your product features Artificial Intelligence. For this feature to work, your product must be added to the HomeWhiz app and connected to the internet.

In the HomeWhiz app, you can turn the AI feature on or off from the helper functions page for your specific product.

Thanks to its autonomous technology, your product adapts to your usage habits, offering high energy efficiency and saving you up to 20%.

- The stated savings figures are obtained under standard laboratory conditions. Your savings figures may vary depending on customer usage conditions and climate.

9.4 Energy Management

Your product has an energy consumption management feature. For this feature to work, your product must be added to the HomeWhiz application and connected to the internet.

You can track your appliance's consumption information using the HomeWhiz app's Energy Management panel.

You can monitor the consumption information of your smart product according to different time periods and save money with suggestions to reduce your consumption.

- The consumption values stated on the product label are obtained under standard laboratory conditions. The consumption values shown in the HomeWhiz app are for informational purposes only and may differ from actual consumption values depending on customer usage conditions and climate.

9.5 Using the Door Water Dispenser

After connecting your product to the water source or changing the water filter, flush the water system. Use a sturdy container to press and hold the water dispenser lever for 5 seconds, then release for another 5 seconds. Continue this cycle until water begins to flow. Once water starts flowing, continue pressing and releasing the water dispenser pedal (press for 5 seconds, release for 5 seconds) until you reach 4 gallons. 15 liters of water has been dispensed. This process purges the air from the filter and water dispenser system, preparing the water filter for use. Additional purging may

be required in some homes. Water may gush from the dispenser as air is removed from the system.

Allow the product to cool for 24 hours and let the water cool. Remove enough water each week to ensure a fresh supply.

After continuously dispensing water for 5 minutes, the water dispenser will stop dispensing water to prevent overflow. To resume dispensing water, press the dispenser pedal again.

*Water fountain at the door

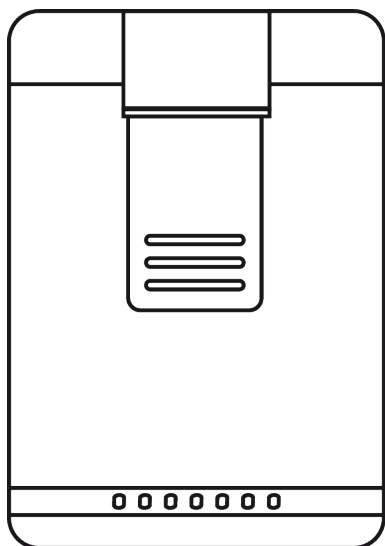

*Water Intake

When you press the pedal to turn on the water fountain, hold a container under the spout of the fountain.

Release the tap to stop drawing water.

It's normal for the first few glasses of water from the spring to be lukewarm.

Use only clean drinking water.

10 Maintenance and Cleaning

Read the "Safety Instructions" first!

- Unplug your appliance before cleaning it.
- The dust on the ventilation grille on the back of the product should be removed (without opening the lid) at least once a year. Cleaning should be done with a dry cloth.

If the water fountain hasn't been used for a long time, pour out the first few cups of water to obtain clean water.

For the first use, you need to wait approximately 24 hours for the water to cool down.

Remove the glass a little while after pulling the trigger.

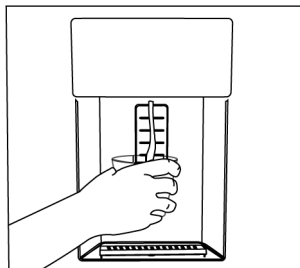

For using the water fountain

Before using your product for the first time and after changing your water filter, water may drip from the dispenser. To prevent water from dripping or leaking from the dispenser, purge 5-6 gallons (approximately 20 liters) of water from the dispenser before using your product for the first time and after each water filter change to remove air from the system. This removes trapped air and prevents the dispenser from leaking. If there is an obstruction in the water flow, the straightness of the water line and the coupling position at the back of the unit should be checked.

It's normal for your water dispenser to leak only a few drops of water after you've taken some.

If you haven't used the water dispenser for a long time, pour out the first few glasses of water to get clean water.

For products that include a water dispenser/ice machine.

- If the water in the tank has been left standing for 2-3 weeks, it should be changed.
- The water tank and water dispenser parts should not be washed in a dishwasher.

- Dissolve one teaspoon of baking soda in half a liter of water. Wet a cloth with this solution and wring it out thoroughly. Wipe the inside of your appliance with this cloth and then dry it completely.
- Ensure that water does not enter the lamp housing, LED light lens, ventilation holes, and other electrical parts. Risk of electric shock and short circuit!
- Do not open or perform cleaning, maintenance, or repair work on electrical components (control board cover, compressor rear cover (if applicable) without authorization. If your product does not have a cover on the compressor area, absolutely do not touch this area or use any tools to come into contact with it. Risk of electric shock and injury!
- Clean the door with a damp cloth. Remove all contents from your product, including the door and body shelves. Lift the door shelves upwards to remove them. After cleaning and drying, slide the shelves back into place from top to bottom.
- Never use chlorine-containing water or cleaning agents for cleaning the exterior surface of the product or chrome-plated parts. Chlorine causes rust on these types of metal surfaces.
- For any reason, do not put your hands, feet, or any metal objects under or between the product. Pinch or any sharp edges could cause personal injury.
- To prevent the prints on the plastic part from peeling off or deforming, do not use sharp, abrasive tools, soap, household cleaning products, detergents, gasoline, polish, etc. For cleaning, use a soft cloth with lukewarm water and dry.
- Use only a slightly damp microfiber cloth for cleaning the exterior surface of the product. Sponges and other types of cleaning cloths may cause scratches.
- To clean the interior surfaces of the product, wash all removable parts with a mild solution of soap, water, and baking soda. Rinse thoroughly and dry completely. Prevent water from getting into the lights and control panel.
- Be careful not to let water get into the lamp housing and other electrical parts.
- Clean the door with a damp cloth. Remove all contents to take out the door and body shelves. Lift the door shelves upwards to remove them. After cleaning and drying, slide them back in place from top to bottom.
- Never use chlorine-containing water or cleaning agents for cleaning the exterior surface of the product or chrome-plated parts. Chlorine causes rust on these types of metal surfaces.
- To prevent the prints on the plastic part from peeling off or deforming, do not use sharp, abrasive tools, soap, household cleaning products, detergents, gasoline, polish, etc. For cleaning, use a soft cloth with lukewarm water and dry.
- In products without No Frost technology; water droplets and up to a finger's thickness of frost will form on the back wall of the cooling compartment. Do not clean it, and absolutely do not apply oil or similar substances.
- Use only a slightly damp microfiber cloth for cleaning the exterior surface of the product. Sponges and other types of cleaning cloths may cause scratches.
- To clean the interior surfaces of the product, wash all removable parts with a mild solution of soap, water, and baking soda. Rinse thoroughly and dry completely. Prevent water from getting into the lights and control panel.
- Do not use vinegar, rubbing alcohol, or other alcohol-based cleaners on any interior surfaces.

For products without No Frost;

- Water droplets and up to a finger's thickness of frost will form on the back wall of the cooler compartment. Do not clean it, and absolutely do not apply oil or similar substances.

Stainless Steel Exterior Surfaces

Use a non-abrasive stainless steel cleaner and apply it with a lint-free, soft cloth. To polish, gently wipe the surface with a microfiber cloth dampened with water and use a dry polishing pad. Always follow the grain of the stainless steel.

Preventing Bad Odors

No substances that could cause odor are used in the production of your product. However, odors may arise due to improper food storage and failure to properly clean the product's interior surface.

11 Troubleshooting

Read the "Safety Instructions" first!

Check this list before contacting the service. Doing so will save you time and money. This list includes frequent complaints that are not related to faulty workmanship or materials. Certain features mentioned herein may not apply to your product.

If the problem persists after following the instructions in this section, contact your vendor or an Authorized Service. Do not try to repair the product.

The refrigerator is not working.

- The power plug is not fully settled. >>> Plug it in to settle completely into the socket.
- The fuse connected to the socket powering the product or the main fuse is blown. >>> Check the fuse.

Condensation on the side wall of the cooler compartment (MULTI ZONE, COOL CONTROL and FLEXI ZONE).

- The door is opened too frequently. >>> Take care not to open the product's door too frequently.
- The environment is too humid. >>> Do not install the product in humid environments.
- Foods containing liquids are kept in unsealed holders. >>> Keep the foods containing liquids in sealed holders.

- To prevent this problem, clean with baking soda water every 15 days.
- Store food in sealed containers, as microorganisms released from open food can cause bad odors.
- Never store expired or spoiled food in your product.

Protection of Plastic Surfaces

If oil spills on plastic surfaces, clean them immediately with warm water, as the oil can damage the surface.

- The product's door is left open. >>> Do not keep the product's door open for long periods.
- The thermostat is set to a very cool temperature. >>> Set the thermostat to an appropriate temperature.

Compressor is not working.

- In case of sudden power failure or pulling the power plug off and putting back on, the gas pressure in the product's cooling system is not balanced, which triggers the compressor thermic safeguard. The product will restart after approximately 6 minutes. If the product does not restart after this period, contact the service.
- Defrosting is active. >>> This is normal for a fully-automatic defrosting product. The defrosting is carried out periodically.
- The product is not plugged in. >>> Make sure the power cord is plugged in.
- The temperature setting is incorrect. >>> Select the appropriate temperature setting.
- The power is out. >>> The product will continue to operate normally once the power is restored.

The refrigerator's operating noise is increasing while in use.

- The product's operating performance may vary depending on the ambient temperature variations. This is normal and not a malfunction.

The refrigerator runs too often or for too long.

- The new product may be larger than the previous one. Larger products will run for longer periods.
- The room temperature may be high. >>> The product will normally run for long periods in higher room temperature.
- The product may have been recently plugged in or a new food item is placed inside. >>> The product will take longer to reach the set temperature when recently plugged in or a new food item is placed inside. This is normal.
- Large quantities of hot food may have been recently placed into the product. >>> Do not place hot food into the product.
- The doors were opened frequently or kept open for long periods. >>> The warm air moving inside will cause the product to run longer. Do not open the doors too frequently.
- The freezer or cooler door may be ajar. >>> Check that the doors are fully closed.
- The product may be set to a temperature that is too low. >>> Set the temperature to a higher degree and wait for the product to reach the adjusted temperature.
- The cooler or freezer door washer may be dirty, worn out, broken or not properly settled. >>> Clean or replace the gasket. Damaged / torn door washer will cause the product to run for longer periods to preserve the current temperature.

The freezer temperature is very low, but the cooler temperature is adequate.

- The freezer compartment temperature is set to a very low degree. >>> Set the freezer compartment temperature to a higher degree and check again.

The cooler temperature is very low, but the freezer temperature is adequate.

- The cooler compartment temperature is set to a very low degree. >>> Set the cooler compartment temperature to a higher degree and check again.

The food items kept in cooler compartment drawers are frozen.

- The cooler compartment temperature is set to a very low degree. >>> Set the cooler compartment temperature to a higher degree and check again.

The temperature in the cooler or the freezer is too high.

- The cooler compartment temperature is set to a very high degree. >>> Temperature setting of the cooler compartment has an effect on the temperature in the freezer compartment. Wait until the temperature of relevant parts reach the sufficient level by changing the temperature of cooler or freezer compartments.
- The doors were opened frequently or kept open for long periods. >>> Do not open the doors too frequently.
- The door may be ajar. >>> Fully close the door.
- The product may have been recently plugged in or a new food item is placed inside. >>> This is normal. The product will take longer to reach the set temperature when recently plugged in or a new food item is placed inside.
- Large quantities of hot food may have been recently placed into the product. >>> Do not place hot food into the product.

Shaking or noise.

- The surface is not flat or durable >>> If the product is shaking when moved slowly, adjust the stands to balance the product. Also make sure the ground is sufficiently durable to bear the product.
- Any items placed on the product may cause noise. >>> Remove any items placed on the product.

- The product is making noise of liquid flowing, spraying etc.
- The product's operating principles involve liquid and gas flows. >>> This is normal and not a malfunction.

There is sound of wind blowing coming from the product.

- The product uses a fan for the cooling process. This is normal and not a malfunction.

There is condensation on the product's internal walls.

- Hot or humid weather will increase icing and condensation. This is normal and not a malfunction.
- The doors were opened frequently or kept open for long periods. >>> Do not open the doors too frequently; if open, close the door.
- The door may be ajar. >>> Fully close the door.

There is condensation on the product's exterior or between the doors.

- The ambient weather may be humid, this is quite normal in humid weather. >>> The condensation will dissipate when the humidity is reduced.

The interior smells bad.

- The product is not cleaned regularly. >>> Clean the interior regularly using sponge, warm water and carbonated water.
- Certain holders and packaging materials may cause odour. >>> Use holders and odour-free packaging materials.

- The foods were placed in unsealed holders. >>> Keep the foods in sealed holders. Micro-organisms may spread out of unsealed food items and cause bad odour.
- Remove any expired or spoiled foods from the product.

The door is not closing.

- Food packages may be blocking the door. >>> Relocate any items blocking the doors.
- The product is not standing in full upright position on the ground. >>> Adjust the stands to balance the product.
- The surface is not flat or durable >>> Make sure the surface is flat and sufficiently durable to bear the product.

The crisper is jammed.

- The food items may be in contact with the upper section of the drawer. >>> Reorganize the food items in the drawer.

Temperature on the product surface.

- High temperature may be observed between two doors, on the side panels and on the rear grill area while your product is operated. This is normal and it does not require servicing.

Fan continues to operate when the door is opened.

- Fan may continue to operate when the freezer door is open.

If the problem persists after following the instructions in this section, contact your vendor or an Authorized Service. Do not try to repair the product. This is normal.

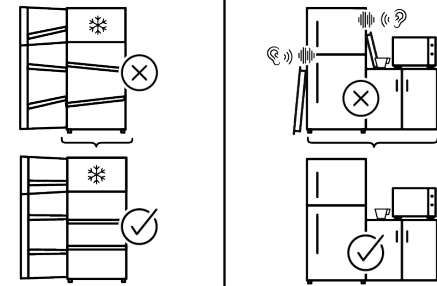
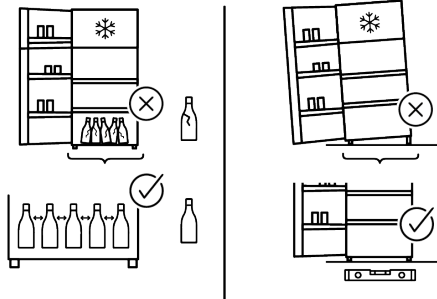
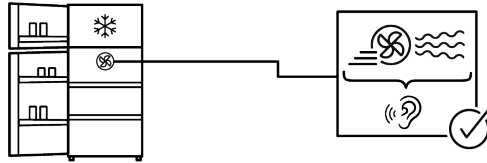
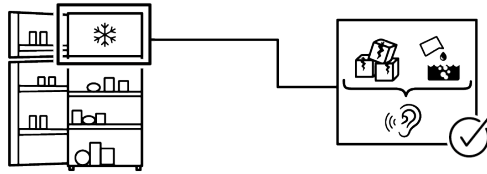
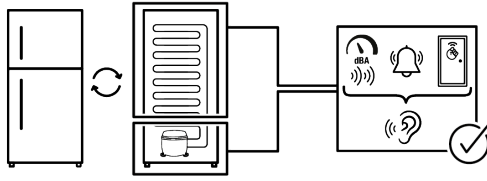

DISCLAIMER

Some (simple) failures can be adequately handled by the end-user without any safety issue or unsafe use arising, provided that they are carried out within the limits and in accordance with the following instructions (see the "Self-Repair" section).

Therefore, unless otherwise authorized in the "Self-Repair" section below, repairs shall be addressed to registered professional repairers in order to avoid safety issues. A registered Professional repairer is a professional repairer that has been granted access to the instructions and spare parts list of this product by the manufacturer according to the methods described in legislative acts pursuant to Directive 2009/125/EC.

However, only the service agent (i.e. authorized professional repairers) that you can reach through the phone number given in the user manual/warranty card or through your authorized dealer may provide service under the guarantee terms. Therefore, please be advised that repairs by professional repairers (who are not authorized by) Hotpoint shall void the guarantee.

Self-Repair

Self-repair can be done by the end-user with regard exclusively to the following spare parts: door handles, door hinges, trays, baskets and door gaskets (an updated list is also available parts-selfservice.europeanappliances.com as of 1st March 2021).

Moreover, to ensure product safety and to prevent risk of serious injury, the mentioned self-repair shall be done following the instructions in the user manual for selfrepair or which are available in parts-selfservice.europeanappliances.com. For your safety, unplug the product before attempting any self-repair.

Repair and repair attempts by end-users for parts not included in such list and/or not following the instructions in the user manuals for self-repair or which are available in

parts-selfservice.europeanappliances.com, might give rise to safety issues not attributable to Hotpoint, and will void the warranty of the product.

Therefore, it is highly recommended that end-users refrain from the attempt to carry out repairs falling outside the mentioned list of spare parts, contacting in such cases authorized professional repairers or registered professional repairers. On the contrary, such attempts by end-users may cause safety issues and damage the product and subsequently cause fire, flood, electrocution and serious personal injury to occur.

By way of example, but not limited to, the following repairs must be addressed to authorized professional repairers or registered professional repairers: compressor, cooling circuit, main board, inverter board, display board, etc.

The manufacturer/seller cannot be held liable in any case where end-users do not comply with the above.

The spare part availability of the refrigerator that you purchased is 10 years. During this period, original spare parts will be available to operate the refrigerator properly. The minimum duration of guarantee of the refrigerator that you purchased is 24 months.

This product is equipped with a lighting source of the "G" energy class.

The lighting source in this product shall only be replaced by Professional repairer.