

# Haier

## PART 1

# User Manual Dishwasher

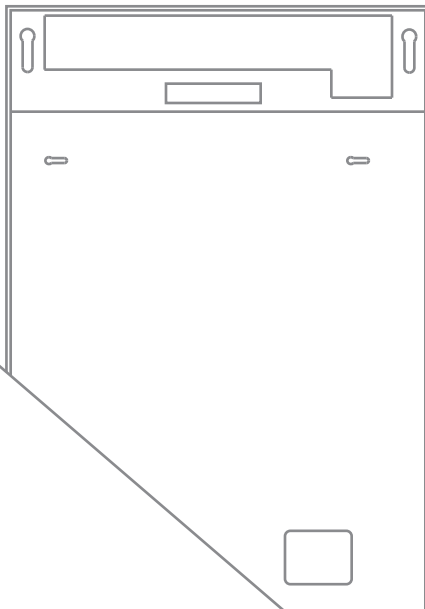

EU

Safety and warnings .....	2
Product Description .....	6
Control Panel .....	7
Programme .....	10
First use .....	11
Loading suggestions .....	12
Setting a wash .....	13
Delayed start .....	15
Keylock .....	16
Preferences .....	17
Water softening system .....	18
Detergent .....	20
Rinse aid .....	22
Daily Use .....	23
Wi-Fi Connection .....	26
Maintenance .....	27
Troubleshooting .....	31
Fault codes .....	34
Standards Test .....	35

## Intended Use

The appliance is designed for domestic use inside the house, or in similar applications such as staff kitchen areas in working environments, farm houses, by clients in hotels, motels or other residential environments, and bed and breakfast environments. It is not intended for commercial or industrial use. Do not use it for purposes other than that for which it was designed.

Changes or modifications to the device are not allowed. Unintended use may cause hazards and loss of warranty claims.

## Standards and Directives

This product meets the requirements of all applicable EC directives with the corresponding harmonised standards, which provide for CE marking.

## Read and save this guide

When using your Dishwasher, follow basic precautions, including the following:

### General

- ▶ The information in this guide must be followed to minimise the risk of fire or explosion or to prevent property damage, personal injury or loss of life.
- ▶ Use the Dishwasher only for its intended function as described in this guide.
- ▶ This appliance is intended to be used in household and similar applications such as:
  - staff kitchen areas in shops, offices and other working environments
  - farm houses
  - by clients in hotels, motels and other residential environments
  - bed and breakfast environments.
- ▶ Use only detergents or rinse aid recommended for use in a domestic dishwasher and keep them out of reach of children. Check that the detergent dispenser is empty after the completion of each wash program.
- ▶ When loading items to be washed, locate sharp items so that they are not likely to damage the Dishwasher and load sharp knives with the handle up to reduce the risk of cut injuries.
- ▶ Do not touch the filter plate in the Dishwasher base during or immediately after use, as it may be hot.
- ▶ Do not operate your Dishwasher unless all enclosure panels are properly in place.
- ▶ Do not tamper with the controls.
- ▶ Do not abuse, sit on, stand in or on the door or dish rack of the Dishwasher.
- ▶ The door should not be left in the open position since this could present a tripping hazard.

- ▶ The foldaway cup racks are designed to support cups, glasses and kitchen utensils. Do not lean on or use the foldaway cup racks to support your body weight.
- ▶ To reduce the risk of injury, do not allow children to play in or on the Dishwasher.
- ▶ Under certain conditions, hydrogen gas may be produced in a hot water heater system that has not been used for two weeks or more. **HYDROGEN GAS IS EXPLOSIVE.** If the hot water system has not been used for such a period, before using the Dishwasher, turn on all hot water taps and let the water flow from each for several minutes. This will release any accumulated hydrogen gas. As the gas is flammable, do not smoke or use an open flame during this time.
- ▶ Remove the door to the washing compartment when removing an old Dishwasher from service or discarding it.
- ▶ Some dishwasher detergents are strongly alkaline. They can be extremely dangerous if swallowed. Avoid contact with the skin and eyes and keep children away from the Dishwasher when the door is open.
- ▶ The Dishwasher must be used with the filter plate, filter, and spray arms in place. To identify what these parts are refer to 'Maintenance'.
- ▶ If the Dishwasher is not being used for long periods of time, turn the electricity and water supply off.
- ▶ Cleaning and maintenance shall not be done by children without supervision.
- ▶ Take care not to load dishware items so they prevent the door from closing.
- ▶ Household appliances are not intended to be used by children. Children of less than 8 years old must be kept away from the appliance unless continuously supervised. This appliance can be used by children aged from 8 years and above, and persons with reduced physical, sensory or mental capabilities or lack of experience and knowledge, if they have been given supervision or instruction concerning the use of the appliance in a safe way and they understand the hazards involved. Children being supervised not to play with the appliance.
- ▶ If a dishwasher cleaner is used, we recommend running a wash program with detergent immediately afterward to prevent any damage.
- ▶ The Dishwasher is designed for washing normal household utensils. Items that are contaminated by petrol, paint, steel, iron debris, corrosive, acidic or alkaline chemicals are not to be washed in the Dishwasher.
- ▶ Do not wash plastic items unless they are marked dishwasher safe or equivalent. For plastic items not marked, check the manufacturer's recommendations.
- ▶ Avoid washing containers with glued on labels. Labels removed during a wash cycle may cause damage to the wash system

## Installation

- ▶ This Dishwasher must be installed and located in accordance with the Installation instructions before it is used. If you did not receive Installation instructions with your Dishwasher, you can order them by calling your Authorised Repairer or download them from our local Haier website, listed on the back cover.
- ▶ Installation and service must be performed by a Haier trained and supported service technician.
- ▶ If the power supply cord is damaged, it must be replaced by a Haier trained and supported service technician or a qualified trades person in order to avoid a hazard.
- ▶ Ensure the Dishwasher is secured to adjacent cabinetry using the brackets provided. Failure to do so may result in an unstable product, which may cause damage or injury.
- ▶ Do not operate this appliance if it is damaged, malfunctioning, partially disassembled or has missing or broken parts, including a damaged power supply cord or plug.
- ▶ Do not store or use petrol, or other flammable vapours and liquids in the vicinity of the Dishwasher.
- ▶ Connect to a properly rated, protected and sized power supply circuit to avoid electrical overload.
- ▶ Ensure the power supply cord is located so that it will not be stepped on, tripped over or otherwise subject to damage or stress.
- ▶ Do not install or store the Dishwasher where it will be exposed to temperatures below freezing or exposed to weather.
- ▶ Do not use an extension cord or a portable electrical outlet device (e.g. multi-socket outlet box) to connect the Dishwasher to the power supply.
- ▶ This appliance must be grounded. In the event of a malfunction or breakdown, grounding will reduce the risk of electric shock by providing a path of least resistance for electric current.
- ▶ This appliance is equipped with a cord having an equipment-grounding conductor and a grounding plug. The plug must be plugged into an appropriate outlet that is installed and grounded in accordance with all local codes and ordinances. Improper connection of the equipment-grounding conductor can result in a risk of electric shock. Check with a qualified electrician or Haier trained and supported service technician if you are in doubt as to whether the appliance is properly grounded.
- ▶ Do not modify the plug provided with the appliance; if it will not fit the outlet, contact a Haier trained and supported service technician or qualified electrician.  
If the Dishwasher is installed as a permanently connected appliance, this appliance must be connected to a grounded metal, permanent wiring system, or an equipment-grounding conductor must be run with the circuit conductors and connected to the equipment-grounding terminal or lead on the appliance.

## Maintenance

- ▶ Disconnect the appliance from the power supply before any cleaning or maintenance.
- ▶ When disconnecting the appliance pull the plug rather than the power supply cord or junction of cord to avoid damage.
- ▶ Do not repair or replace any part of the appliance or attempt any servicing unless specifically recommended in this guide. We recommend contacting a Haier trained and supported service technician or Customer Care.
- ▶ Keep the floor around your appliance clean and dry to reduce the possibility of slipping.
- ▶ Keep the area around/underneath your appliance free from the accumulation of combustible materials, such as lint, paper, rags and chemicals.

- ▶ Ensure the installer has completed the 'Final checklist' in the Installation instructions.
- ▶ Read this guide, taking special note of the 'Safety and warnings' section.
- ▶ Remove all internal and external packaging and dispose of it responsibly. Recycle items that you can.

## Dishwasher overview

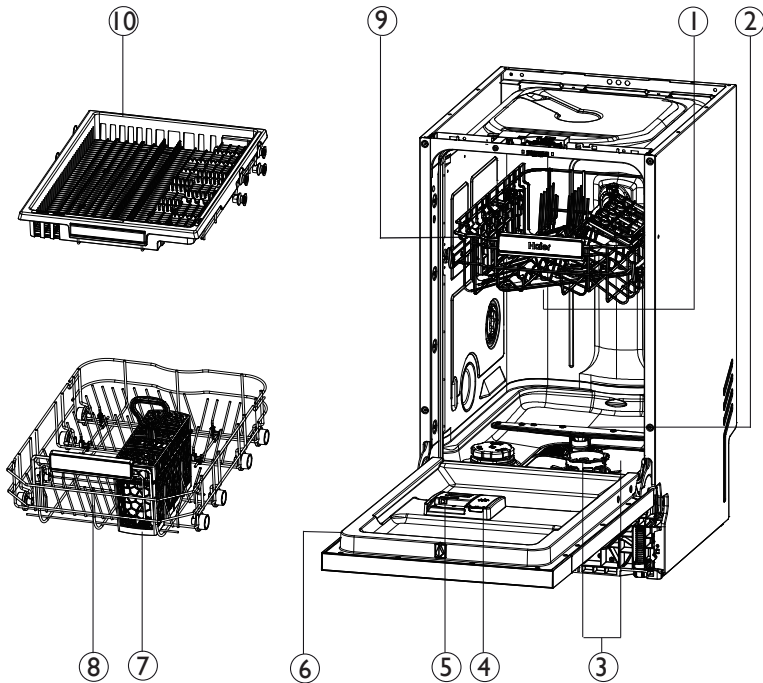

- |                        |                         |
|------------------------|-------------------------|
| 1. Middle spray arm    | 6. Rating label         |
| 2. Lower spray arm     | 7. Cutlery/Utensil tray |
| 3. Filter              | 8. Lower basket         |
| 4. Rinse aid dispenser | 9. Upper basket         |
| 5. Detergent dispenser | 10. Third basket*       |

\*Models with 11 place settings have only third basket.

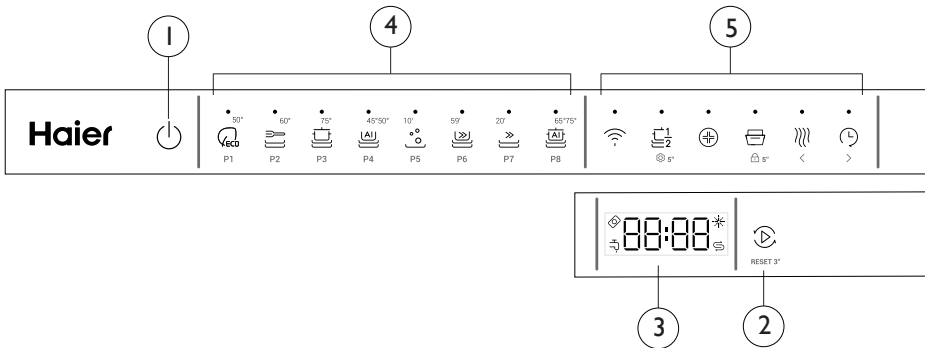

1. ON/OFF icon
2. START/RESET icon
3. Time&Info Display/Indicator icon
4. PROGRAMME icon
5. Option icon

## Time & Info display

During any selection the display shows related information like

- ▶ Programme cycle time
- ▶ Programme start delay time
- ▶ Error codes

After start of an operation it displays without flashing

- ▶ Remaining time in hours of a delayed programme starts, e.g. 24:00
- ▶ Remaining programme cycle time in hours + minutes, e.g. 1:59

While running it may vary due to local conditions and daily working load.



## Floor light

Use the external floor light to check if there is a wash running while the dishwasher door is closed.

### Floor light logic

NO LIGHT	No wash running
SOLID LIGHT	Wash running
SLOW FLASHING	Wash paused/door open
FAST FLASHING	Dishwasher has a fault

## Indicator Icon

Tabs



If the indicator lights up, the Tabs function has been activated.

Water tap



If the indicator lights up, the appliance does not fill with water. Check section: "TROUBLE SHOOTING"

Rinse aid



If the indicator lights up: Rinse is empty. After adding Rinse, the indicator lights off.

Salt aid



If the indicator lights up: Salt is empty. After adding Salt, the indicator lights off.

## Optional function

Wifi



Press the icon, and the app can start the dishwasher program.

Half load



Adjusts the wash program to more efficiently wash smaller loads.

Hygiene



Raises the water temperature during the rinse phase to sanitize.

## Auto Door



Automatically open the door a few centimeters to allow air to circulate. Improve drying effect.

## Extra Dry



Increases the final rinse temperature and the length of the drying phase.

## Delay



You can delay the start of a programme up to 24 hours.

## Child Lock



Hold down the icon for 5 seconds to lock or unlock the option of other icons.

## Tabs



Hold down the icon for 5 seconds to activate the User setting mode. Then you can activate the Tabs function. This option allows you to optimize the performance of the program by simply choosing the type of detergent you want to use.

## WASH PROGRAM

## Additional function

ECO

1/2load, Hygiene, Auto Door, Dry, Tabs

UNIVERSAL

1/2load, Hygiene, Auto Door, Dry, Tabs

INTENSIVE

1/2load, Hygiene, Auto Door, Dry, Tabs

AUTO CARE

1/2load, Auto Door, Dry, Tabs

PREWASH

/

59MIN

1/2load, Hygiene, Auto Door, Tabs









RAPID 20'

1/2load, Auto Door, Tabs

AUTO PLUS

1/2load, Hygiene, Auto Door, Dry, Tabs

Your dishwasher has a number of wash programs designed to suit your needs. Selecting the most appropriate cycle for each load will help ensure the best wash results.

Wash program	Program description
ECO 	For normally soiled dishes for optimum water and energy usage
UNIVERSAL 	Best for dishes that are quite heavily soiled or to remove food soils that have been left to dry overnight
INTENSIVE 	Designed for heavily soiled pots, pans and dishes
AUTO CARE 	1) Suitable for any type of load. The dishwasher automatically selects the optimum wash program
PREWASH 	2) Prevents odours and soils from dishes, no drying
59MIN 	Use for dishes that are quite heavily soiled or food soils that have been left to dry overnight
RAPID 20' 	For very lightly soiled dishes
AUTO PLUS 	1) Suitable for any type of load. The dishwasher automatically selects the optimum wash program

1). The appliance senses the type of soil and the quantity of items in the baskets. It automatically adjusts the temperature and quantity of water, energy consumption and programme duration.

2). Use this programme to quickly rinse the dishes. This prevents the remaining food to bond on the dishes and bad odours to come out from the appliance. Do not use detergent with this programme.

## Dishware

The combination of high temperatures and dishwasher detergent may cause damage to some items. Refer to the manufacturer's guidance or wash by hand if in doubt.

### Cutlery & silverware

Rinse cutlery and silverware immediately after use to prevent tarnishing. Silver should not come into contact with stainless steel, mixing these can cause staining. Remove silver cutlery from the dishwasher and hand dry immediately.

### Aluminium

Aluminium can be dulled by detergent. The degree of change depends on the quality of the detergent or aluminium.

### Other metals

Iron and cast iron can rust and stain other items. Copper, pewter and brass tend to stain.

### Woodware

Woodware is generally sensitive to heat and water. Regular use in the dishwasher may cause deterioration over time.

---

## Water hardness

Hard water is water with a high concentration of minerals such as calcium and magnesium. It can be detrimental to the performance of your dishwasher and parts can fail over time. Glassware washed in hard water will become cloudy over time and dishes will become spotted or covered in a white film. Water hardness varies by geographical location. If you live in a hard water area, we recommend fitting a water softener to the household water supply.

### If your home has hard water

- Refer to 'Powdered detergent quantity recommendations'.
- Use rinse aid. We recommend you raise the rinse aid setting to help improve wash performance. Refer to 'Preferences' for details.

Use a dishwasher cleaner/descaler regularly, or whenever you notice a build-up of limescale deposits in your dishwasher.

### If your home has soft or softened water

- Avoid using too much detergent.

### Glassware

Most glassware is dishwasher safe. Crystal, very fine and antique glassware may etch and develop a cloudy appearance.

### Plastics

Some plastics may change shape or colour with hot water. Refer to the manufacturer's guide. Dishwasher safe plastic should be weighed down so it does not flip and fill with water or fall through the base rack during the wash.

### Decorated items

Most modern china patterns are dishwasher safe. Antique items, those with a pattern painted over the glaze, gold rims or hand painted china may be more sensitive to machine washing.

### Glued items

Certain adhesives are softened or dissolved in machine washing.

When loading your Dishwasher ensure items are placed so water coming from the rotating spray arm below can reach all areas. Wash performance will be reduced if it can't.

Your dishwasher can hold up to a maximum of 11 place settings.

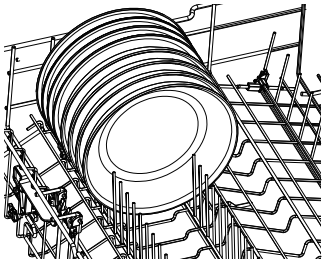

## Ensure

- Lower and middle spray arms can rotate freely.
- Tall items do not obstruct the upper spray arm.
- Glass and other fragile items are stable.
- All dish openings are facing downwards.
- Plates are evenly spaced.
- All sharp objects are located securely to avoid injury or damage to the product.

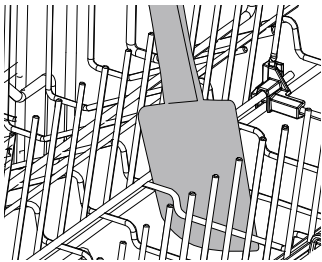

## Avoid

- Overcrowding.
- Any protrusions below the racks and basket that may prevent spray arm rotation.
- Any protrusions at the front of the dishwasher.
- Blocking water from any items on the foldaway cup racks.

1

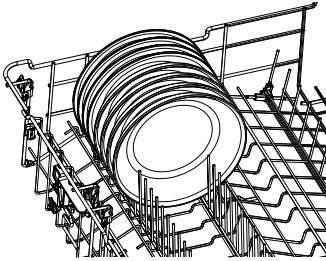

Remove all food scraps from dishware before carefully loading into the dishwasher. Ensure the spray arms are free from any obstructions and rotate freely.

2

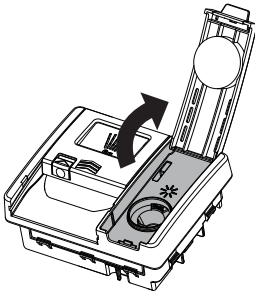

If the rinse aid indicator is illuminated, fill the rinse aid dispenser. Refer to 'Rinse aid' for additional guidance.

3

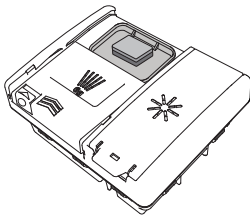

Add detergent to the dispenser and close the cover. Tablets can be placed in the detergent dispenser.

4

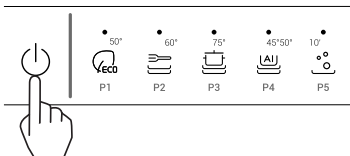

Make sure the dishwasher is powered on, press the .

# Setting a wash

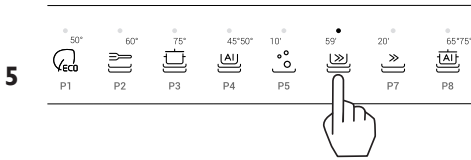

Select a wash modifier if required.



Press  to start the wash and close the door.

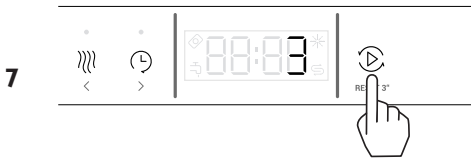

Open the door slowly at any point during the wash to pause.  
Press and hold  3 seconds to cancel.

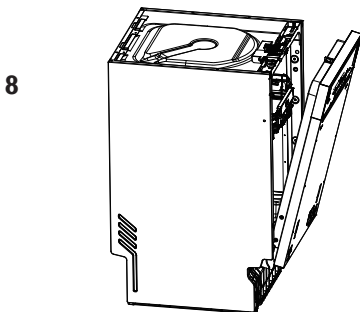

After the wash the door will automatically open slightly to assist with drying.\*  
For best results, unload dishes once cooled.

\* This function can be activated or not by the user.

Set your dishwasher to start later in the day and run a selected wash program. DELAYED START can be set after a wash program has been selected and can be set for up to 24 hours.

## Setting Delayed Start

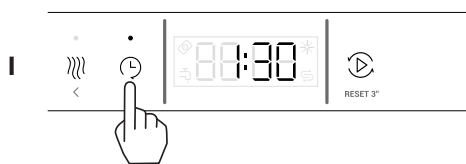

Add detergent and select a wash program, and wash modifier if required.

Press to enter DELAYED START and increase the delay time.

\*For the 0-4 hours, increase or decreases by 30min each press, and for 4-24 hours, increase or decreases by 1h.



Press to confirm and promptly close the door.

The wash program will begin at the end of the countdown, provided the door is closed.

3

Open the door to pause DELAYED START. Close the door to continue.

## Cancelling Delayed Start



Open the door and press and hold 3 seconds to cancel.



Lock the dishwasher controls for cleaning or to prevent unintended use.

## Locking the controls

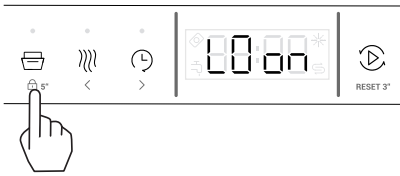

Press and hold  for 5 seconds to lock the dishwasher controls.

Note: Before locking the controls, running the program. After locking, except for the unlocking and turn off operation, other functions are not available.

## Unlocking the controls





Press and hold  for 5 seconds to unlock.

You can adjust any of the below settings prior to starting a wash cycle.

Option	Description	Default	Settings display
<b>Water softener adjustment</b>	Adjust according to the following page.	So4	-So- So1-So6 Min: So1 Max: So6
<b>Rinse aid</b>	Controls the amount of rinse aid dispensed. Refer to 'Rinse aid' for further details.	r3	-r- r1-r4 Min: r1 Max: r4
<b>Sound</b>	Adjusts tone settings. When set to OFF all tones will be silenced except fault alerts.	Son	-S- On Son Off SoF
<b>Memo setting</b>	Program memory function, select whether to remember the program last use.	LoF	-L- On Lon Off LoF
<b>Tabs</b>	Adjust according to the following page.	PoF	-P- On Pon Off PoF

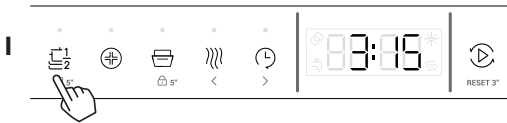
## Changing the setting



Ensure there is no wash in progress. Press and hold  for 5 seconds to enter the menu.

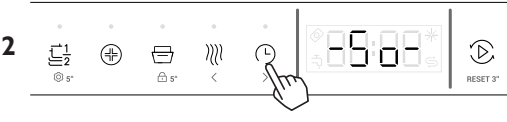

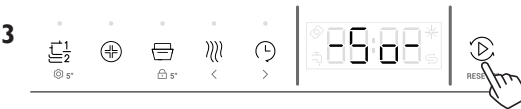

Press  to scroll through the settings.

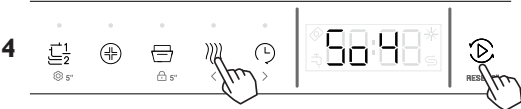

Press to select the menu you want to adjust.



Press  or  to adjust the level.  
Press to save the settings.

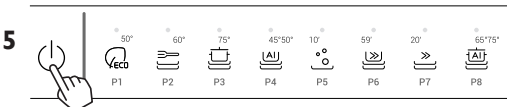

Press  to exit.

To ensure good washing results, the dishwasher requires soft water. Hard water can be detrimental to the performance of your dishwasher. Over time, glassware washed in hard water will become opaque and dishes will become spotted or covered in a white film. Using white film. Using very hard water can cause dishwasher parts to fail over time. Salt can improve the situation.

## Adjusting the water softening system

The amount of salt dispensed can be set in So1 and So6 stages, depending on the hardness of your water.

1. Find out about the hardness value of your tap water. Your water utility company will help you with this.
2. Setting can be found in the water hardness table.

## Identify the local water hardness

Water hardness				Water softener adjustment
German degrees(°dH)	French degrees(°fH)	Mmol/l	Clarke degrees	electronic
31-50	55-89	5.5-8.9	39-63	So6
17-30	30-54	3.0-5.4	21-38	So5
13-16	23-29	2.3-2.9	16-20	So4 <sup>1)</sup> *
9-12	16-22	1.6-2.2	11-15	So3
0-8	0-15	0-1.5	0-10	So2 <sup>2)</sup> *
-	-	-	-	So1 <sup>3)</sup> *

\* Remark

- 1) Factory default setting for powder detergent.
- 2) Recommended setting for combi detergent tablets.
- 3) Indicator for Salt is off.

## Using special salt

As soon as the low salt indicator is lit on the control panel ,salt should be topped up.Always refill with special salt immediately before switching on the appliance.This ensures that overrun special salt solution is immediately washed out and does not corrode the rinsing tank.

## Top up the salt as follows:

### **▲ CAUTION**

Only use dishwasher salt. Other products can cause damage to the appliance! Any spilled salt causes corrosion.Run a programme after each refill.

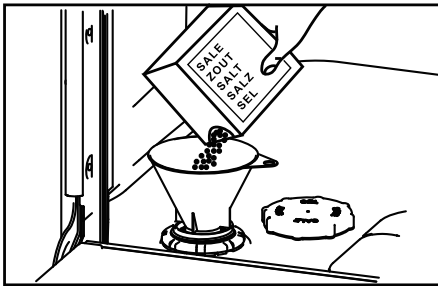

1. Turn the cap clockwise to open the salt container.
2. Fill with 1 litre of water into the salt container.
3. Fill the tank up with specific salt (water overflows).
4. Remove spilled salt from the opening area.
5. Turn the cap counter-clockwise to close the salt container.

**WARNING:** Dishwasher detergents are strongly alkaline. They can be extremely dangerous if swallowed. Avoid contact with the skin and eyes and keep children and infirm persons away from the dishwasher when it is open. Check the powdered detergent dispenser is empty after each wash.

## Unsuitable detergents

These types of detergent are not suitable and may damage your dishwasher or lead to a service call that is not covered by warranty:

- ▶ Hand washing liquids
- ▶ Laundry detergents
- ▶ Soaps
- ▶ Disinfectants

## Using powdered detergent

For powdered detergent quantities, refer to the following 'Powdered detergent quantity recommendations' table and the detergent manufacturer's guidance.

1

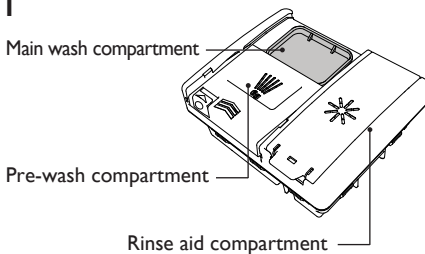

Check that the dispenser is empty and dry. Add powdered detergent or tablets to the detergent dispenser.

2

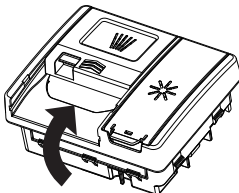









Remove any excess detergent then slide the cover closed. It will click into place. If required, add additional detergent to the pre-wash compartment on top of the dispenser.

When washing heavily soiled dishware in hard water, more detergent may be required. Refer to 'Powdered detergent quantity recommendations'.

## Powdered detergent quantity recommendations

- ▶ Use the table below to determine the optimal powdered detergent quantity for each wash program.
- ▶ If you have hard water in your area, more detergent may be required.

Wash program	Pre wash compartment	Main wash compartment
ECO <small>50°</small>  <small>P1</small>	Full	2/3
UNIVERSAL <small>60°</small>  <small>P2</small>	Full	2/3
INTENSIVE <small>75°</small>  <small>P3</small>	Full	2/3
AUTO CARE <small>45°/50°</small>  <small>P4</small>	Full	1/2 - 2/3
PREWASH <small>10°</small>  <small>P5</small>	None	None
59MIN <small>59°</small>  <small>P6</small>	Full	1/2
RAPID 20' <small>20°</small>  <small>P7</small>	None	1/2
AUTO PLUS <small>65°/75°</small>  <small>P8</small>	Full	1/2 - 2/3

Rinse aid provides a streak-free finish to glass and dishware as well as preventing metal from tarnishing. We recommend using a liquid rinse aid regularly for optimal drying results.

The rinse aid dispenser is located on the inside of the door next to the detergent dispenser.

## Using rinse aid

The amount of rinse aid dispensed in each wash may need to be adjusted to suit your water conditions. Refer to 'Preferences' and 'Water hardness' for guidance. Rinse aid is not required if tablet has it already built into it.

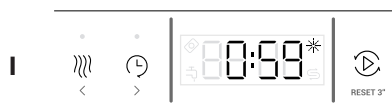

When the rinse aid level is low, the rinse aid indicator on the control panel will light up to remind you to refill the dispenser.

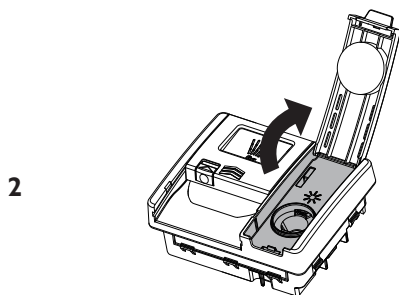

Lift the cover open and pour rinse aid into the opening.  
Do not fill past the MAX line. Take care not to spill any onto the door or detergent bucket.

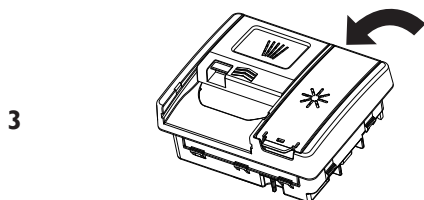

Close the cover, ensuring it clicks shut.

Any accidental spillages into the dishwasher or detergent bucket must be cleaned up immediately. Spilt rinse aid may result in excessive foaming. A service call relating to these errors will not be covered by warranty.

## Load the Baskets



With delicate glasses and porcelain make sure they are labelled dishwasher-proof.

- × Do not put in the appliance items made of wood, horn, aluminium, pewter and copper.
- × Do not put in the appliance items that can absorb water (sponges, household cloths).
- ▶ Only use the appliance to wash items that are dishwasher-safe.
- ▶ Remove remaining food from the items.
- ▶ Soften burned food on the items before washing.
- ▶ Put hollow items (cups, glasses and pans) with the opening down.
- ▶ Put items with deep hollows in a slanted position.
- ▶ Mix spoons with other cutlery to prevent them to bond together.
- ▶ Make sure that cutlery and dishes do not bond together and there is a gap between each item.
- ▶ Make sure that glasses do not touch other glasses.
- ▶ Put small items in the cutlery basket.
- ▶ Put light items in the upper basket. Make sure that the items do not move.
- ▶ Make sure that the spray arms can move freely before you start a programme.



If jingling noises are heard during a programme run: Check that the dishes and glassware have a firm position.

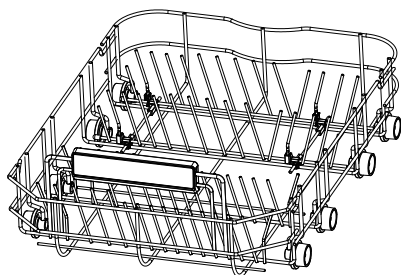

Place heavily soiled items (like pots and pans or dinner plates) in the bottom basket. The more powerful spray jet provides a better dishwashing result.



## Upper baskets

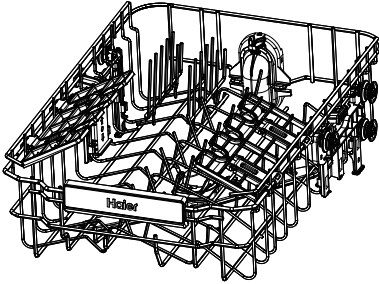

- ▶ The upper basket is designed to hold items like glasses, cups, saucers, plates, small bowls and shallow pans.

## Foldable cup racks

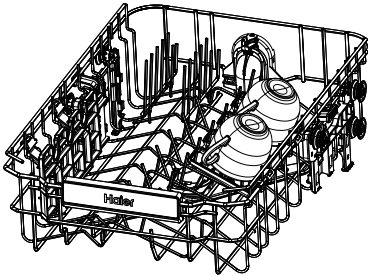

Adjust the height to suit or fold out of the way to make space for other items. Use the notches to support wine glass stems.

Folding and support can be achieved by flipping.

## Height adjustment of the upper basket.

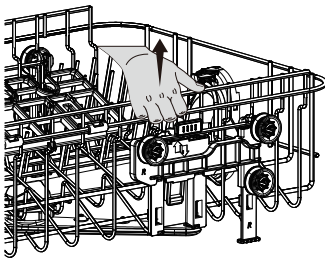

TO RAISE BASKET

Grip these handles both sides and lift basket upwards until it clicks in place.

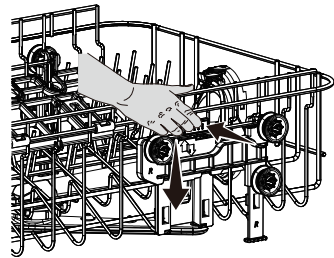

TO LOWER BASKET

Press the levers on both sides and carefully lower the basket.

## Cutlery basket

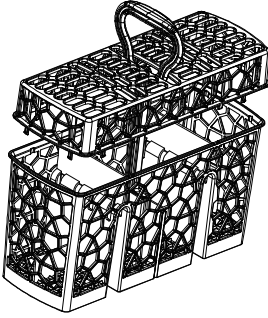

Place Cutlery with the handles down for better washing results. If long items may block the spray arms find a horizontal positioning in the upper basket.

## Cutlery/Utensil tray

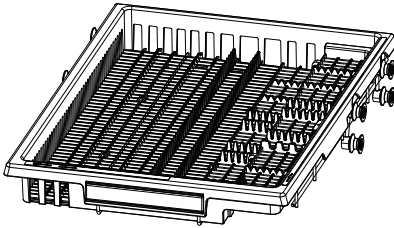

Use the tray to secure cutlery and utensils. Place cutlery into the notches to secure. Place larger utensils in the middle of the tray. Flip side sections to the middle to create more space for items below.

Your appliance can be connected to your home wireless network and Selected remotely using the app.

## Getting started

Ensure your home Wi-Fi network is turned on.

You will be given step by step guidance on both your appliance and mobile device. It may take up to 10 minutes to connect your appliance.

For further guidance and troubleshooting, please refer to the app.

## On your mobile device:

1. Download the app from:



2. Register and create an account.

3. Add your appliance and set up the Wi-Fi connection.

## Connecting to your home Wi-Fi

With the product in standby:

Press , the display will show .

You can now, follow the prompts in the app to complete set-up.

## Enabling Remote mode

1. When the machine is not connected with app, the  icon keeps blinking.

When the machine is connected with app, the  icon keeps lighting.

2. Remote control is automatically activated, the mobile app can start the dishwasher program. You can control the dishwasher by app, such as: select a cycle, cancel or pause a cycle, add the additional functions.

3. When start a program by APP, you need to press the wifi button on the machine for remote control each time.

Disconnect the dishwasher from the power supply and allow it to cool before undertaking any cleaning or maintenance.

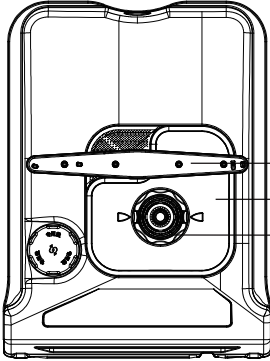

## Features

- 1 Filter
  - 2 Filter plate
  - 3 Lower spray arm
- Not shown: middle and upper spray arms

## Cleaning surfaces

Wipe with a damp cloth and dry using a lint-free cloth. We do not recommend using the following cleaning aids as they may damage the surfaces:

- Plastic or stainless steel scouring pads
- ▶ Abrasive, solvent, household cleaners
- ▶ Acid or alkaline cleaners

- Hand washing liquids or soap
- ▶ Stainless steel cleaners or polishes
- ▶ Laundry detergents or disinfectants

## Cleaning the filter, spray arms and filter plate

We recommend that the drain filter and filter plate are removed and cleaned once a month or whenever there is evidence of food particles. The spray arms in normal use should require cleaning less frequently. Lower and middle spray arms can be shaken to remove any foreign material, cleaned in hot water, then rinsed in clean water.

The dishwasher must be used with the filter plate, drain filter and spray arms correctly in place. If using a dishwasher cleaner or descaler, refer to manufacturer instructions.

## Extended periods of disuse

If your dishwasher is not going to be used for some time we recommend turning off the power and water supply, leaving it clean and empty with the door ajar. When using your dishwasher for the first time after a long period away, we recommend pouring 3 cups of water into the dishwasher before use. This helps lubricate components that may have dried out during disuse.

## Removing and cleaning the filter

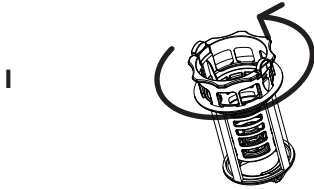

Twist the filter anti-clockwise to release. Lift to remove.

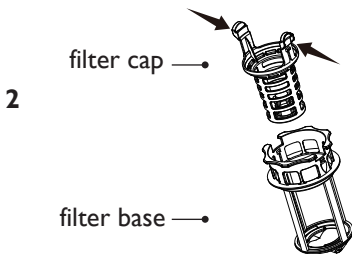

Separate the filter cap from the base by pressing the release buttons and lifting. Do not attempt to remove the filter by force as this may cause damage. Clean under hot water and rinse thoroughly.

## Replacing the filter

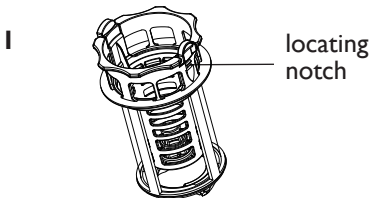

Align the filter cap with the notch on the filter base. Ensure that the buckle structure is in place.

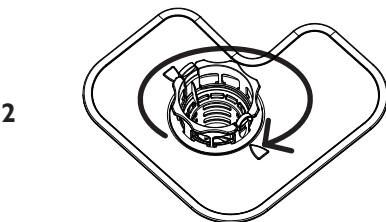

Place the drain filter back into the dishwasher base. Rotate 2 clockwise to click into place.

## Removing and cleaning the filter plate

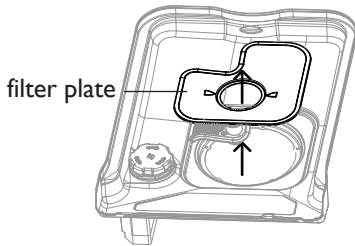

With the filter removed, carefully lift the filter plate up and out.  
Clean under hot water and rinse thoroughly.

## Replacing the filter plate

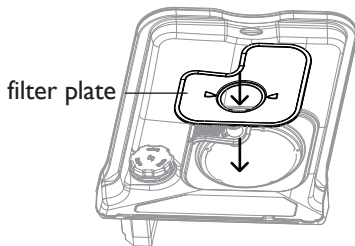

Slot the filter plate under the locating clips at the rear of the drain and push firmly back into place. Ensure the filter plate is flush with the dishwasher base.

## Cleaning the top spray arm

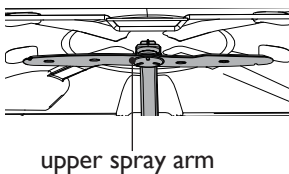

Do not remove the top spray arm for cleaning. Clean with a small, plastic-bristled brush. If heavily soiled or blocked use a dishwasher cleaner/descaler. Follow the manufacturer's instructions.

## Cleaning the middle spray arm

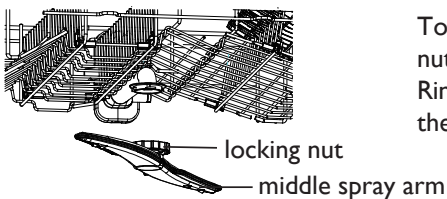

To remove the middle spray arm, turn the locking nut clockwise to release. Rinse the spray arm thoroughly under running water, then refit.

## Cleaning the lower spray arm

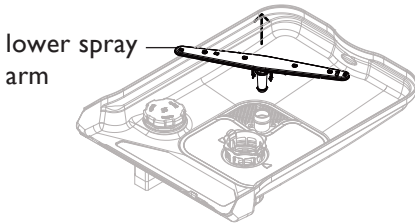

To remove the lower spray arm, lift it from the base of the dishwasher.

Rinse the spray arm thoroughly under running water, then refit.

Ensure the arm rotates freely when refitted.

## Winterizing (cold climates)

If the Dishwasher is installed in a cold climate where temperatures fall below zero, we recommend winterizing.

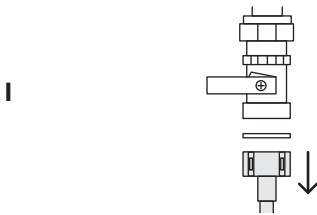

Turn off the water supply.

Disconnect the drain hoses from the sink drain pipe and the water inlet pipe from the water valve.

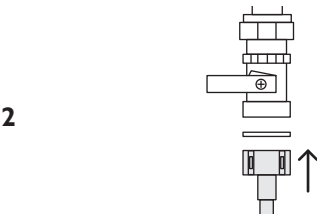

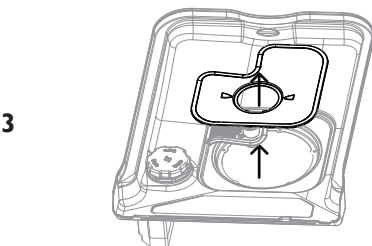

Drain the water from the hoses, inlet pipe and water valve, using a bucket or pan to collect the water.

Reconnect the water inlet pipe to the water valve and hoses to the sink drain pipe.



Remove the drain filter and the filter plate. Use a sponge to remove any remaining water from underneath before replacing.

Problem	Possible cause	What to do
Dishwasher will not start	No power.	Ensure the dishwasher is plugged in and the power supply is turned on at the wall.
	The door is not properly closed.	Close the door.
	 has not been pressed.	Press  .
	Water tap not turned on.	Ensure water is connected and turned on.
Lower spray arm rotates with difficulty	Blocked strainer in water inlet hose.	Check the strainer and clean if necessary – it is located where the water inlet hose screws into the tap.
	Spray arm holes are blocked by small items or food particles.	Clean the spray arm. Refer to 'Maintenance' for instructions.
Cover of detergent dispenser cannot be closed	Detergent compartment has been overfilled.	Remove detergent until the cover can be closed.
	Detergent dispenser is clogged with remnants of detergent.	Wipe dispenser out with a damp cloth. Dry the dispenser before adding detergent.
Remnants of detergent stuck inside dispenser	Compartment was damp when filled with detergent.	Wipe dispenser out with a damp cloth. Dry the dispenser before adding detergent.
	Utensils are blocking the detergent dispenser from opening.	Ensure there are no large utensils positioned in a way that will stop the dispenser cover from opening when the dishwasher door is closed.
Water remains inside dishwasher after wash has ended	Blocked drain connection.	Check that drain connection is free from blockages.
	Drain hose is crimped, bent, or blocked.	Check the drain hose and straighten if needed.
	Pump is jammed.	Call your Haier Authorised Service Centre or Customer Care.
	Filter(s) blocked.	Clean the filter(s). See 'Maintenance' for instructions.
Display flashing while Keylock is on	This is normal. The display remains on although the buttons are disabled.	No action required.



<b>Problem</b>	<b>Possible cause</b>	<b>What to do</b>
Foaming	Incorrect amount or type of detergent used.	Refer to 'Detergent' or consult the detergent manufacturer's instructions.
	Too much egg in the wash load.	Increase the amount of detergent.
	Rinse aid dosage level too high.	Decrease the rinse aid dosage.
	Rinse aid spills not wiped up.	Ensure that all rinse aid spills are wiped up when they occur.
Knocking or rattling sound during wash	Spray arm knocking against dishes.	Pause the wash and rearrange dishes. Refer to 'Setting a wash' and 'Loading suggestions'.
	Dishes have been stacked incorrectly.	
Unclean dishes	Unsuitable wash program for load selected.	Select the appropriate wash program for the load. Refer to 'Wash programs'.
	Soils were too heavily baked on.	Dishes may need soaking.
	Spray arm(s) unable to rotate.	Ensure no items are obstructing the spray arm path.
	Basket/rack incorrectly loaded.	Refer to 'Loading suggestions'.
	Filter plate or filter incorrectly installed.	Refer to 'Maintenance'.
	Detergent put in the wrong compartment.	Refer to 'Wash programs' and 'Detergent'.
	Excessive food not removed from dishes before loading.	Scrape all food scraps off dishes before loading.
	Unsuitable detergent.	Only use powdered or tablet detergent designed for domestic dishwashers.
	Not enough detergent.	Refer to 'Detergent' for recommended quantities. You may need to adjust these to suit your particular load and the hardness of your water supply.
	Spray arm holes are blocked.	Clean the spray arm(s). Refer to 'Maintenance' for instructions.
The filters are blocked.	Clean the filters. Refer to 'Maintenance' for instructions.	

<b>Problem</b>	<b>Possible cause</b>	<b>What to do</b>
Plastic items are discoloured (e.g. stain left by tomato sauce)	Not enough detergent, not pre-rinsed.	Pre-rinse plastic dishes before placing in the dishwasher and/or add more detergent. Alternatively, using the Rinse program after adding dishes may minimise staining.
The dishwasher stops suddenly during the wash	Power or water supply has been interrupted.	Check the power and water supplies.
White stains are left on dishes glasses ; have a milky appearance	Not enough detergent.	Refer to 'Detergent' for recommended quantities. You may need to adjust these to suit the hardness of your water supply.
	Rinse aid dosage too low.	Increase rinse aid dosage. Refer to 'Rinse aid'.
	Rinse aid dosage too low.	Increase rinse aid dosage. Refer to 'Rinse aid'.
Dishes, cutlery have not dried	Items removed too soon.	After the end of the wash program, leave the door ajar and wait for several minutes to help drying.
	Rinse aid dispenser empty. (The rinse aid indicators are lit.)	Add rinse aid. Refer to 'Rinse aid'.
Glasses have dull appearance	Rinse aid dosage too low.	Increase rinse aid dosage. Refer to 'Rinse aid'.
Tea stains or traces of lipstick have not been completely removed	Not enough detergent.	See section 'Detergent' for recommended quantities. You may need to adjust these to suit your particular load.
	Wash temperature too low.	Select a wash program for heavily soiled dishes. Refer to 'Wash programs' for information.
Traces of rust on cutlery	Cutlery is not sufficiently rustproof.	Wash by hand.
Glasses clouded and discoloured; milky coating	Hard water situation.	Increase detergent quantities.
	Glasses are not dishwasher proof.	Wash by hand.

Problem	Possible cause	What to do
Water marks left on glasses and cutlery	Rinse aid level or dosage setting is too low.	Ensure there is rinse aid in dispenser. If necessary, increase the rinse aid setting or try using a wash program with a higher temperature. Refer to 'Rinse aid' for information.
Salt Aid Indicator is lighted.	Softener salt is empty.	Fill the tank up with specific salt until full.

## Fault codes

### Error codes on the display

Follow the steps below to try and fix the issue.

Problem	Possible cause	What to do
<b>E10</b> No water	Water tap not turned on.	Ensure the water is connected and turned on. Touch to restart the dishwasher.
	Insufficient water supply pressure.	Check household water pressure.
	Water inlet hose is crimped or bent, so no or not enough water gets to the dishwasher.	Check the water inlet hose and straighten if needed. Touch to restart the dishwasher.
<b>E30</b> Leak	There are water leakages in the appliance.	Close the water tap.
	The water inlet valve is open and blocked.	Disconnect appliance from power supply.
	The drainage is blocked.	Contact Service.

Wash programme	Eco The program has auto-door opening function by default.
Powder detergent quantities	19g
Rinse aid dosage level	r1-r4, r3(default)
Maximum number of place settings	11
Height adjustment of upper basket	Ensure the upper basket is in its lower most position

## Recommended loading patterns



Cutlery/Utensil tray



Upper basket



Lower basket

Wash programme	Eco The program has auto-door opening function by default.
Powder detergent quantities	18g main wash
Rinse aid dosage level	r1-r4, r3(default)
Maximum number of place settings	10
Height adjustment of upper basket	Ensure the upper basket is in its high most position

### Recommended loading patterns



Upper basket

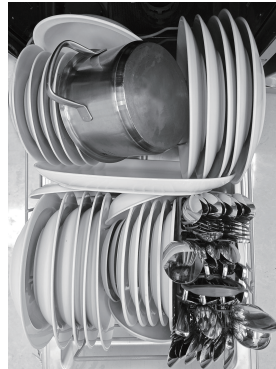

Lower basket



条形码尺寸40\*8mm, 由厂家生成。

012050\*\*\*\*