



Manual for installation,
use and maintenance

MDI6011

Integrated Dishwasher



Contents:

- 3 Important information
- 5 Important notes
- 6 Recommendations and steps before first use
- 7 Using your appliance
- 10 Buzzer sound control
- 11 Save power mode
- 12 Detergent
- 13 Salt
- 14 Softener adjustment
- 15 Rinse aid
- 17 Dishwasher baskets
- 18 Standard loading and test data
- 19 Programme listing
- 20 Care and maintenance
- 22 Failure codes and troubleshooting
- 23 Troubleshooting
- 24 Electrical information
- 26 Installation
- 29 Fitting the decor door
- 30 Warranty and service

Important

- Read the instructions prior to installation and use of the appliance.
- Do not lean or climb on the open dishwasher door, to prevent damage.
- Close the dishwasher door after use, to prevent accidents.
- Use only detergents, salt and rinse aid specifically designed for dishwashers.
- Do not put solvents in the dishwasher detergent compartment, to prevent risk of explosion.
- Only put dishwasher safe items into the dishwasher. If in doubt, check with the manufacturer of the items.
- Take care when loading the dishwasher to observe the recommendations for best loading practice, and also to ensure that sharp objects such as knives are placed blade down, to prevent accidents.
- Do not open the dishwasher door when a programme is running. If it is necessary to do so, then open it only slightly to allow the dishwasher to pause the programme and prevent any water spilling out. Remember that the water in the dishwasher can be very hot when the programme is running.
- When the dishwasher is not in use, we recommend that you turn off the water supply at the supply tap and disconnect the mains supply.
- If you are leaving the dishwasher for an extended period you should leave the door slightly open to prevent the formation of unpleasant smells.
- The plastic housing on the water inlet pipe contains an

electrically operated valve. The wires that connect to this valve are inside the inlet hose. Do not cut through the inlet hose, and do not put the plastic housing in water.

- Children could get locked inside the appliance. Therefore when disposing of an old appliance, cut off the plug and set aside, and damage the door lock so that the door can no longer be closed.
- This appliance can be used by children aged from 8 years and above and persons with reduced physical, sensory or mental capabilities or lack of experience and knowledge if they have been given supervision or instruction concerning use of the appliance in a safe way and understand the hazards involved. Children shall not play with the appliance. Cleaning and user maintenance shall not be made by children without supervision.

The CDA Group Ltd cannot be held responsible for injuries or losses caused by incorrect use or installation of this product. Please note that CDA reserve the right to invalidate the guarantee supplied with this product following incorrect installation or misuse of the appliance.

This appliance is not designed to be used by people (including children) with reduced physical, sensorial or mental capacity, or who lack experience or knowledge about it, unless they have had supervision or instructions on how to use the appliance by someone who is responsible for their safety.

Under no circumstances should any external covers be removed for servicing or maintenance except by suitably qualified personnel.

Appliance information

Please enter the details on the appliance rating plate below for reference, to assist CDA Customer Care in the event of a fault with your appliance and to register your appliance for guarantee purposes.

| | |
|-----------------|--|
| Appliance Model | |
|-----------------|--|

| | |
|---------------|--|
| Serial Number | |
|---------------|--|

EU Declarations of Conformity

This product meets the requirements of all applicable EU directives with the corresponding harmonised standards, which provide for CE marking.

Availability of this manual in an alternative format:

A soft copy of this manual is available for download from www.cda.eu.

IMPORTANT INFORMATION FOR CORRECT DISPOSAL OF THE PRODUCT IN ACCORDANCE WITH EU DIRECTIVE 2012/19/EU.

At the end of its working life, the product must be taken to a special local authority waste collection centre or to a dealer providing appliance recycling services.

Disposing of a household appliance separately avoids possible negative consequences for the environment and health. It also enables the constituent materials to be recovered, saving both energy and resources. As a reminder of the need to dispose of household appliances separately, the product is marked with a crossed-out wheeled dustbin. 

Recommendations

- To reduce energy and water consumption, remove all dirt residues from the dishes prior to loading the dishwasher.
- Loading the dishwasher to the capacity indicated by the manufacturer will save energy and water.
- Place hollow items (bowls, glasses and pans) face down in the basket.
- Do not put dishes, cutlery or other items with tobacco ash, wax, lubricating grease or paint residues in the dishwasher.
- It is not recommended to pre-rinse the tableware, as this leads to an increase in water and energy consumption.
- Washing tableware in a household dishwasher usually uses less energy and water than washing up by hand.

Before First Use

- Set the water softener level as required for the water hardness in the area.
- Add 1kg of salt into the salt compartment and then fill with water to the top of the salt compartment.
- Remove all the packaging materials from the interior of the dishwasher.
- Fill the rinse aid compartment.
- Run a hot programme without any dishes in the dishwasher.

Control Panel

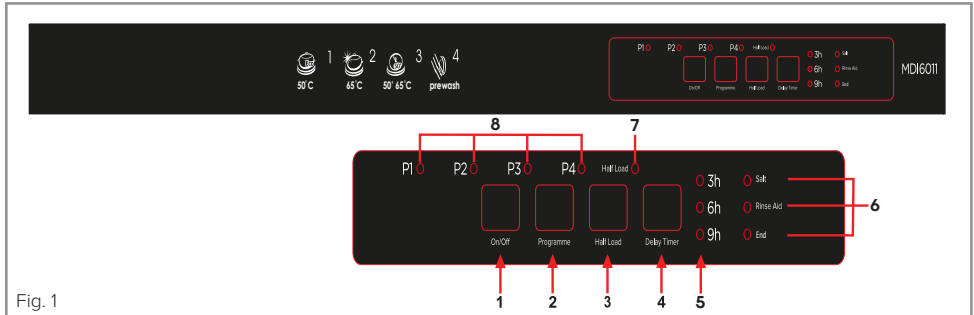

Fig. 1

“On/Off” button (1)

To switch the dishwasher on or off, press the “On/Off” button (1). When you switch on the dishwasher, two dashes will appear on the programme display .

“Programme Selection” button (2)

To select a programme, press the “Programme Selection” button (3). The dishwasher will store in its memory the last programme used.

Half load button (3) and indicator light (7)

The dishwasher is equipped with a half-load function that allows for small numbers of dishes to be washed, spread between both baskets. This reduces the amount of water and electricity used. To use this function, press the half-load button (3). The indicator light (7) will illuminate and shows that this function is selected.

“Delay timer” button (4)

The dishwasher is equipped with a delay timer which will delay the start of a programme for 3, 6 or 9 hours. Pressing this button (4) once will delay the start time for 3 hours, and continuing to press will increase the delay time.

Press the Delay button to change or cancel the delayed start. If you switch off the machine while delay timer is active, the delayed time is cancelled. The delay time indicator (5) will illuminate for the corresponding time set.

“Salt” and “Rinse Aid” warning lights and “End of Programme” light (6)

When either the dishwasher salt or rinse aid begins to run out, a warning light will illuminate to advise that it needs refilling.

When the programme is complete, the dishwasher will emit five beeps and the “End of Programme” light will illuminate.

“Programme Indicator” lights (8)

These lights will illuminate to confirm which programme has been selected. If there is a fault on the dishwasher, the fault code will show on these lights (page 20).

Starting a programme

- Press the “On/Off” button (the “End of Programme” light will be switched on).
- Press the “Programme Selection” button until the required programme is shown on the indicator lights.
- Once a programme is selected, the “End of Programme” light will switch off.
- When you close the dishwasher door, the programme will start automatically.
- If possible, avoid opening the door once a programme has started.

Please note: The dishwasher stores the most recently used programme in its memory. To change the programme, simply press the “Programme Selection” button.

At the end of a programme

At the end of a programme, the dishwasher will beep five times, and the “End of Programme” indicator light will switch on.

Changing a programme

It is possible to change the programme, if necessary, once the programme has started.

- First open the door slightly to reduce the risk of water spillage.
- Press the “Programme Selection” button until the required programme is shown on the display.
- Close the door. The dishwasher will begin the new programme from the point at which the old programme stopped.

Cancelling a programme

It is possible to cancel a programme once it has started.

- First open the door slightly to reduce the risk of water spillage.
- Press and hold in the “Programme Selection” button until the “End of Programme” indicator flashes.
- Close the door. The dishwasher will run a drain cycle which will take approximately 30 seconds. Once this is complete, the dishwasher will beep five times and the “End of Programme” light will switch on.

Switching the dishwasher off

- Once the dishwasher beeps five times and the “End of Programme” light switches on, the dishwasher can be switched off by pressing the “On/Off” button.
- If leaving the appliance off for a long time, turn off the water tap and remove the plug from the power socket.

Please note: The dishwasher should automatically continue on the programme it has started if the door is opened or in the event of a power cut.

Buzzer sound control

To change the buzzer sound level, follow the below steps:

1. Open the door and press Programme (2) and Half Load (3) buttons simultaneously for 3 seconds.
2. When sound setting is recognized, buzzer gives a long sound and machine will display last set level, from "S0" to "S3".
3. To decrease sound level press Programme button (2). To increase sound level, press Half load button (3).
4. When the sound level is changed, corresponding LEDs illuminate as shown in the table below.

| Sound level | LEDs | | | |
|-------------|-----------|----|----|----|
| | Half Load | 3h | 6h | 9h |
| S0 | | | | X |
| S1 | | | X | X |
| S2 | | X | X | X |
| S3 | X | X | X | X |

5. To save the selected sound level, turn off the machine. "S0" level means all sounds are off. The factory setting is "S3"

Save Power Mode

To activate or deactivate Save Power Mode, follow the below steps:

1. Open the door and press the Half Load (3) and Delay Timer (4) buttons simultaneously for 3 seconds.
2. After 3 seconds, the machine will display last Setting.
3. When Save Power Mode is activated, P1, P2 and the Half Load indicator will illuminate. On this mode, interior lights will turn off 4 minutes after the door is opened, and the machine will turn off after 15 minutes of no activity in order to save energy.
4. When Save Power Mode is deactivated P1 and P2 LED's will illuminate. If Save Power Mode is deactive, interior lights will be on as long as the door is open, and the machine will always be on unless it is turned off by the user.
5. To save the selected setting, turn off the machine.

In factory setting, Save Power Mode is active.

Detergent

To fill the detergent compartment

- Push the latch to open the compartment.
- Add the required amount of detergent.

The main detergent compartment “b”

(Fig. 2) has lines to allow for specific amounts of detergent. These are marked at either 15cm³ or 25cm³, to be used depending on how dirty the dishes are.

If your dishes are in need of an intensive wash, then add 5cm³ of detergent into the prewash section of the compartment “a” (Fig. 2).

- Close the detergent compartment lid until the latch locks.



Please note: You should only use detergents designed specifically for use in dishwashers.

If using dishwasher tablets, always use the detergent compartment, do not put them in the main body of the dishwasher or in the cutlery basket. The solubility of dishwasher tablets can vary depending on the temperature and duration of the programme. As a result, it is recommended that powder detergents should be used in the shorter programmes to allow better performance.

The use of separate detergent, rinse aid and dishwasher salt is recommended rather than combination tablets as separates achieve better wash performance.

If you do use combination detergents, add salt and rinse aid to the dishwasher and then adjust the water hardness setting and rinse aid

setting to the minimum. When you then use separate detergents again, you should fill the salt and rinse aid compartments, adjust the water hardness setting to the maximum and run an empty wash, then adjust the water hardness setting and the rinse aid setting to the appropriate level.

Salt

To ensure the best efficiency, the dishwasher needs soft water. Hard water means that lime residues remain on the dishes and the interior of the dishwasher, affecting performance. The softener system is designed to remove the ions that make the water hard and provide the best quality wash performance. This is achieved by using dishwasher salt.

To add dishwasher salt

- Remove the lower dishwasher basket and then unscrew the salt compartment cap (Fig. 3).
- Fill the compartment with dishwasher salt (do not use table salt) carefully, to reduce the risk of spillage (Fig. 4). Before first use, you should fill the salt compartment with 1kg of dishwasher salt and then top up the compartment with water (up to the brim of the compartment) (Fig. 4).
- Replace the cap and the lower basket.

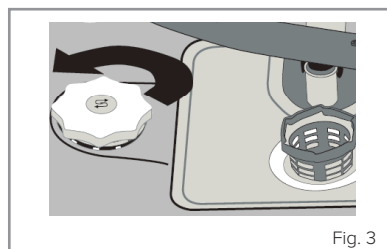

Fig. 3

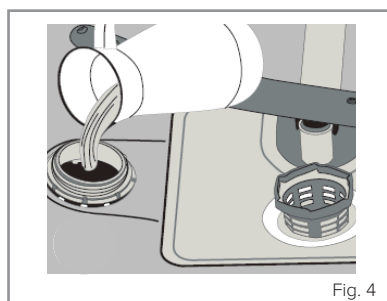

Fig. 4

When the salt warning light on the control panel illuminates, you should refill the salt compartment with salt only – do not add water to the salt compartment after the first use.

Important:

You should run a prewash programme immediately after adding dishwasher salt, to prevent any damage to the dishwasher system.

Softener Adjustment

The efficiency of your dishwasher depends on the softness of the tap water. To ensure best efficiency, the dishwasher is equipped with a system that reduces the hardness in the mains water supply. The efficiency will increase when the system is correctly set. To find out the water hardness level of your water supply you can use the test strip supplied, or alternatively contact your local water board.

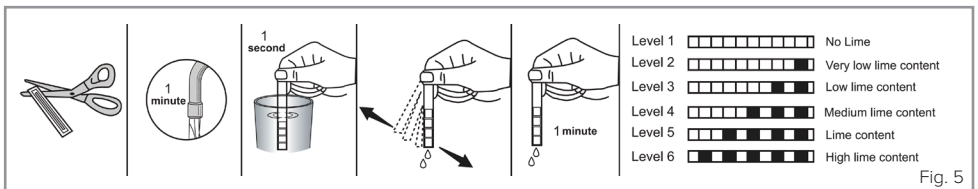

- Open the testing strip (Fig. 5).
- Run water through the tap for one minute.
- Hold the testing strip in water for one second.
- Remove from the water and shake the test strip to remove excess water.
- Wait for one minute.
- Check the number of marks on the strip to see the level of water hardness.

If the hardness of the water you use is above 63dE, or if you are using well water, you are recommended to contact your local water board to confirm the water hardness level and to use filter and water refinement devices.

Please note: The water hardness is preset to level “3”.

To change the hardness setting

- Press the “On/Off” button to switch on the dishwasher.
- Press and hold down the “Programme Selection” button.
- Keep the “Programme Selection” button pressed until all “Programme Indicator” lights flash.
- To adjust the level, press the “Programme Selection” button until the required level is achieved. The “Programme” lights will illuminate as per the table below.
- To store the selected water hardness level, press the “On/Off” button.

| Water hardness level | British hardness dE | Indicator lights illuminated |
|----------------------|---------------------|------------------------------|
| 1 | 0-6 | P1 & 9h |
| 2 | 7-14 | P2 & 9h |
| 3 | 15-21 | Half load & 9h |
| 4 | 22-28 | 3h & 9h |
| 5 | 29-39 | 6h & 9h |
| 6 | 40-63 | P1, 6h & 9h |

Rinse aid

Rinse aid helps to ensure better quality wash results and increased drying performance.

To fill the rinse aid compartment, open the rinse aid compartment lid.

Fill the compartment with rinse aid to the MAX level and then close the lid. Be careful not to overfill the rinse aid compartment and ensure that you wipe up any spillages.

In order to change the rinse aid level, follow the steps below before turning on the machine:

1. Press and hold down the 'Programme selection' button
2. Press the 'On/Off' button to switch on the dishwasher
3. Keep the 'Programme selection' button pressed until all leds blink twice
4. To adjust the level, press the 'Programme selection' button until the required level is shown on the display, as listed in the table on below.
5. To store the selected rinse aid level, press the 'On/Off' button.

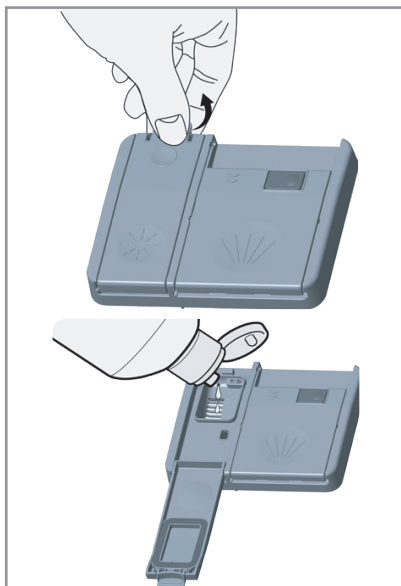

| Level | Brightener dose | Indicator lights illuminated |
|-------|-------------------------|------------------------------|
| 1 | Rinse aid not dispensed | P1 & 9h |
| 2 | 1 dose is dispensed | P2 & 9h |
| 3 | 2 doses are dispensed | Half load & 9h |
| 4 | 3 doses are dispensed | 3h & 9h |
| 5 | 4 doses are dispensed | 6h & 9h |

If the dishes are not drying properly or are spotted with food debris, dirt etc., increase the rinse aid level. If blue stains appear on your dishes, decrease the rinse aid level.

Always refill the rinse aid when the rinse aid indicator light on the control panel is illuminated. Many brands of rinse aid (as well as detergents) contain phosphates which escape sewage treatment and can cause excessive algae growth in waterways. This in turn can pollute drinking water and cause marine life 'dead zones' which are underwater environments deprived of oxygen that are subsequently unable to support life. Please consider the environment and, if you wish to use rinse aid, try to source an environmentally friendly brand.

Dishwasher Baskets

To adjust the height of the upper basket

- Open the basket retaining clips (Fig 9), turning them to the side.
- Remove the upper basket, and relocate the alternate set of wheels on the runner (Fig. 10), pushing the basket back into place.
- Close the basket retaining clips.

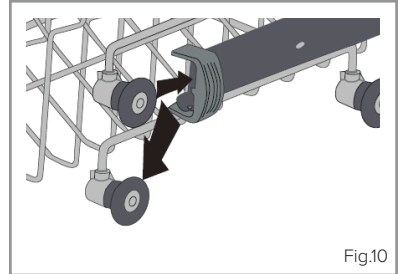
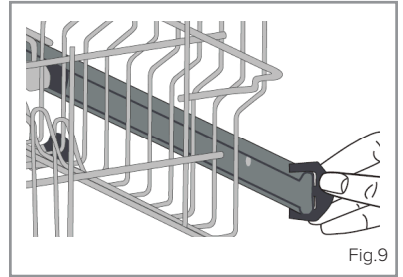

The images below are provided as guidance as to best practice for loading the dishwasher.

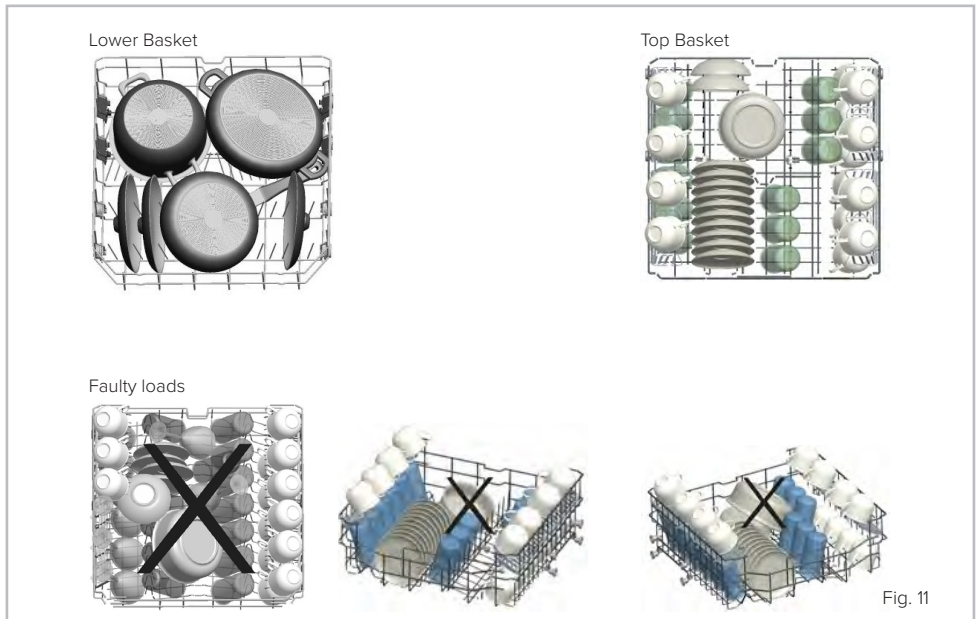

Upper basket racks

The upper basket racks have two positions: Open (A) and closed (B). You can place cups on the racks to be washed. You can also place forks, knives and spoons on the racks laterally.

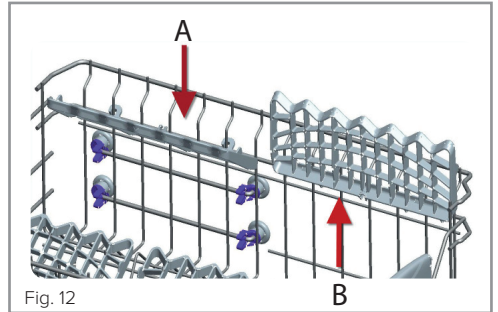

Standard Loading and Test Data

Capacity

- Upper and lower baskets: 12 place settings.
- The upper basket should be adjusted to high position.
- Cups should be placed onto the dish rack pins.

Detergent / Rinse aid

- 5 + 25cm³, in accordance with EN50242-DIN 44990 IEC436 (international norms) / Rinse aid dosage adjustment: 5.

Programme test

- Eco 50°C, in accordance with EN50242 (international norms.).

Programme listing

The values and times provided in the adjacent table have been obtained under laboratory conditions according to relevant standards. Actual results obtained can vary depending on the conditions of the dishwasher's use and environment. (mains supply voltage, water pressure, water input temperature and environmental temperature).

Laboratory measured value in accordance with European standard EN50242.

| | P1 | P2 | P3 | P4 |
|--|----------|----------------|---------------|---------|
| Programme Name | Eco 50°C | Intensive 65°C | Super50' 65°C | Prewash |
| Level of soil | Medium | Heavy | Medium | Light |
| Amount of detergent: A = 25cm ³ B = 15cm ³ | A | A | A | - |
| Programme Duration (h:mm) | 03:25 | 01:57 | 00:50 | 00:15 |
| Electricity consumption (kWh/cycle) | 0.923 | 1.700 | 1.100 | 0.020 |
| Water consumption (l/cycle) | 12.0 | 17.2 | 12.0 | 4.5 |

Care and maintenance

Before beginning any care or maintenance, you should always disconnect the appliance from the electricity supply, and also turn off the water supply.

Door seals

Wipe the dishwasher door seals regularly with a damp cloth to remove any residues.

Filters

You should clean the filters at least once a month.

- Remove the lower basket.
- Turn the micro-filter anticlockwise and then lift it out (Fig. 13).
- Remove the coarse filter from the micro-filter (Fig. 14).
- Remove the base filter from the dishwasher compartment (Fig. 15).

You should clean and rinse the filters thoroughly before replacing all the sections in reverse order to that above. The microfilter should lock into place once it is secure (Fig. 16).

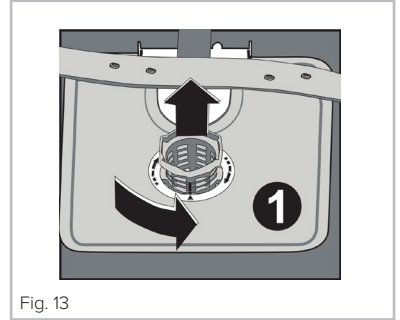

Fig. 13

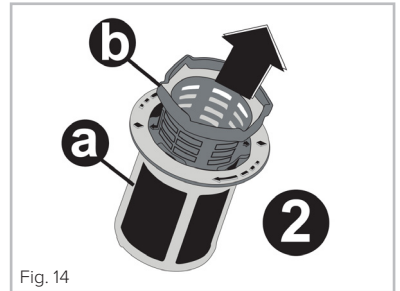

Fig. 14

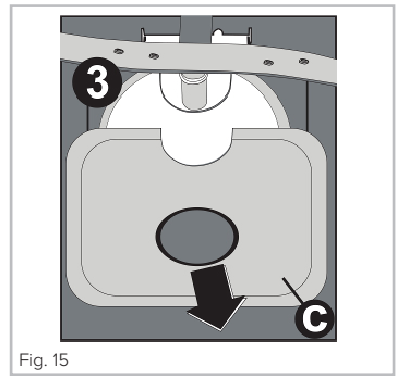

Fig. 15

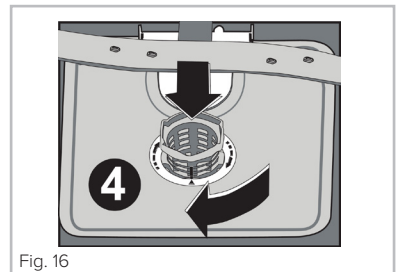

Fig. 16

Please note: Never run a programme without the filters in place. Incorrect fitting of the filters may reduce wash performance and potentially damage your appliance.

Spray arms

You should clean the spray arms at least once a month.

- Remove the lower basket.
- Pull the lower spray arm upwards to remove it.
- To remove the upper spray arm, first remove the nut on the upper spray arm by turning it.

You should clean and rinse the spray arms thoroughly before replacing them. Ensure that the upper spray arm nut is securely tightened when refitting the upper spray arm.

Dishwasher interior

To deal with an accumulation of dirt, oil or limescale in the dishwasher, run an intensive programme with detergent when the dishwasher is empty.

Alternatively, there are specialist dishwasher cleaners available that can be used.

Failure codes and troubleshooting

The “Programme Indicators” also serve as a diagnostic display to help in the event of a problem with the appliance.

| Error Code | | | | | Error description | Advice |
|------------|----|-----------|----|----|---|---|
| P1 | P2 | Half load | 3h | 6h | | |
| | | | | | Inadequate water supply | Make sure the water inlet tap is fully open Close the water tap, separate the water inlet hose from the tap and clean the filter Restart your machine, contact Customer Care if the error resumes |
| | | | | | Pressure system failure | Contact Customer Care |
| | | | | | Continual fill error | Close the tap and contact Customer Care |
| | | | | | The waste water in the machine cannot be discharged | Water discharge hose and filters may be clogged Remove foreign bodies such as food residue or glass shards Restart the dishwasher and cancel the programme. If the error continues, contact Customer Care |
| | | | | | Heater error | Contact Customer Care |
| | | | | | Overflow | Turn off the dishwasher and disconnect the water supply. Contact Customer Care |
| | | | | | Faulty electronic card | Contact Customer Care |
| | | | | | Overheating | Contact Customer Care |
| | | | | | Faulty heater sensor | Contact Customer Care |
| | | | | | High voltage failure | Contact Customer Care |
| | | | | | Low voltage failure | Contact Customer Care |

Troubleshooting

| Problem | Possible cause |
|--|--|
| The programme will not start. | <p>Check the plug, fuse and circuit breakers of the mains supply.</p> <p>The water tap is turned off.</p> <p>The dishwasher door is not fully closed.</p> <p>The mains inlet hose is kinked or trapped.</p> <p>The water inlet filter or the machine filters are blocked.</p> |
| Water remains inside the dishwasher at the end of a programme. | <p>The water drain hose is blocked or kinked.</p> <p>The filters are blocked.</p> |
| The dishwasher stops in the middle of a programme. | <p>Power failure.</p> <p>Water inlet failure.</p> <p>Programme is on standby.</p> |
| Wash performance is of a low standard. | <p>Poor loading of dishes hinders wash performance (See Fig. 11 on page 16).</p> <p>Insufficient detergent added.</p> <p>Inappropriate wash programme selected.</p> <p>Spray arm is blocked.</p> <p>Filters clogged or incorrectly fitted.</p> <p>Water drain pump is blocked.</p> |
| White stains on the dishes. | <p>Insufficient detergent added.</p> <p>Rinse aid setting is too low.</p> <p>Insufficient dishwasher salt added.</p> <p>Water softener setting is too low.</p> <p>Salt compartment cap may not be completely closed.</p> |
| The dishes are not completely dry at the end of a programme. | <p>A programme without a drying stage was selected.</p> <p>Rinse aid setting is too low.</p> <p>Dishes unloaded too soon (allow time for drying).</p> |
| There are rust stains on the dishes. | <p>Different sets of cutlery should be kept separate.</p> <p>Too much salt (water softener setting is too high).</p> <p>Salt compartment cap not completely closed.</p> <p>Poor appliance earth (check mains electrical supply).</p> |
| The door is not opening or closing properly. | <p>Door tension not correctly adjusted for the decor door.</p> |

Electrical Information

Warning! This appliance must be earthed.

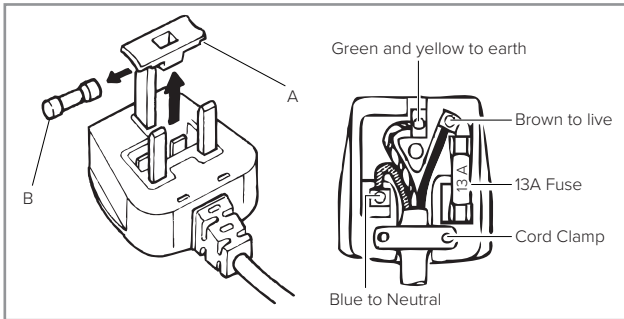

The mains lead of this appliance has been fitted with a BS 1363A 13A fused plug. To change a fuse in this type of plug, follow the steps below:

1. Remove the fuse cover and fuse.
2. Fit replacement 13A fuse, ASTA approved to BS 1362 type, into the fuse cover.
3. Replace fuse cover.

Important: Do not use the appliance without the fuse cover in position.

How to connect an alternative plug

If the fitted plug is not suitable for your socket outlet, then it should be cut off and disposed of safely to avoid the risk of electric shock. A suitable alternative plug of at least 13A rating to BS 1363 should be used.

As the colours of the wires in the mains lead of this appliance may not correspond with the coloured markings identifying the terminals in your plug, proceed as per the following page.

- The wire which is coloured GREEN and YELLOW must be connected to the terminal which is marked with letter (E) or by the Earth symbol \perp or coloured GREEN and YELLOW.
- The wire which is coloured BLUE must be connected to the terminal which is marked with the letter (N) or coloured BLACK or BLUE.
- The wire which is coloured BROWN must be connected to the terminal which is marked with the letter (L) or coloured RED or BROWN.

If in doubt regarding the electrical connection of this appliance, consult a qualified electrician. Do not shorten the supply cable, the appliance may require removing for servicing.

N.B. Ensure that the plug socket is situated in an easily accessible place.

If the power supply cord is damaged, it must be replaced by a CDA authorised agent.

Installation

- Do not install this appliance if it is damaged in any way. Installing a damaged appliance may invalidate the warranty and could cause further damage to the surrounding area.
- **Do not hold the appliance by the door or control panel to move it as this may cause damage.** We recommend seeking the help of another individual when moving and installing this appliance.
- We would recommend leaving a certain clearance either side of the dishwasher so that removal of the appliance is easier, should the need arise.
- The water supply tap should be located in an adjacent cupboard so that it can be accessed after installation.
- Ensure the appliance is level by adjusting the feet as necessary. Problems with the level seating of the appliance can lead to issues with the door opening and closing.
- Only use the water inlet supplied with the appliance.
- If the water pressure is above 10 bar, a pressure relief valve should be used.
- After connecting the water supply, check to ensure there are no leaks.
- The water outlet can either be connected to a water drain or to a sink outlet spigot. **Where the dishwasher drain hose is to be connected to a sink spigot, ensure that the spigot is cut/opened (if required) before attaching the drain hose.**
- The drain connection (fig. 14) should be at a minimum of 600mm and a maximum of 1100mm from the floor. The drain hose should be no longer than 4m in length to ensure good performance from the dishwasher.
- **This appliance is cold fill only.**

Figures 14 and 15 **on page 27** show the recommended installations of our dishwashers. The set-ups in these figures should be mimicked wherever possible to help to ensure the best performance of the appliance. **Please carry out the below checks/measures before, during and after installation.**

Drain hose

- This can be connected to a water drain or to a sink outlet spigot. Where the hose is to be connected to a spigot, ensure that the spigot is cut/opened (if required) before attaching the hose. A circlip can be used to secure this connection. **Observe the 150mm minimum height distance between the spigot and drain hose support as per fig. 15.**
- The drain hose support (fig. 16) must be secured at a minimum of 60cm and a maximum of 110cm from the floor **and must be higher than the sink waste.**
- Should be no longer than 4m in order to ensure good performance.
- **Must be free from kinks, debris or damage.** It is important that this is checked before and after installation.

Inlet hose

- This **must be free from kinks, debris or damage.** This must be checked before and after installation.
- Should have a bend radius of 200mm minimum to ensure the proper flow of water to the appliance.
- Ensure the supply to the hose (water valve) is turned on.

- Use the additional fitting template and kit supplied with the appliance to fit the appliance into the cabinet, secure it and fit and secure the decor door.
- Adjust the dishwasher door hinge tension as necessary to ensure the appliance door opens and closes properly and safely with the decor door attached. There are labels on the dishwasher door to advise you. An improperly fitted (or adjusted) decor door will prevent the appliance door from opening and closing as normal and could cause issues with operation such as leaks.

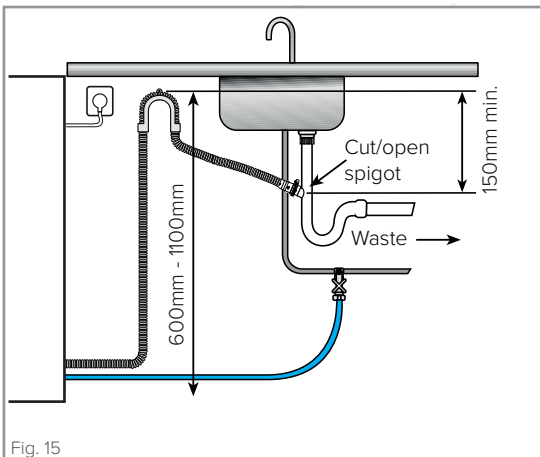
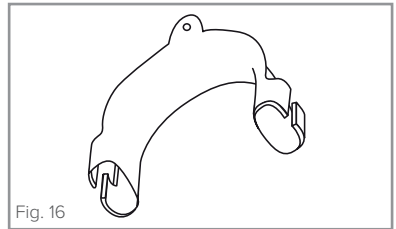
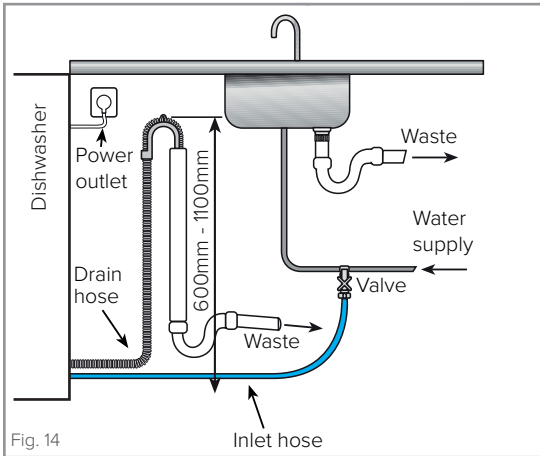

Fitting the decor door

Where non-standard decor doors are to be used, additional fitting instructions are required to ensure compatibility with this product.

The appliance is supplied with a fitting template and these instructions should be followed as normal.

However, the fitting template needs to be located lower down the fascia door. This is shown below:

The amount of offset, Y , depends upon the height of the fascia door and can be calculated as $X = 723\text{mm}$.

For example, if you have a 731mm tall fascia door and are fitting a door to your dishwasher, then $Y = 731 - 723 = 8\text{mm}$.

Ensure that the hinge tensioners are adjusted to balance the weight of the door.

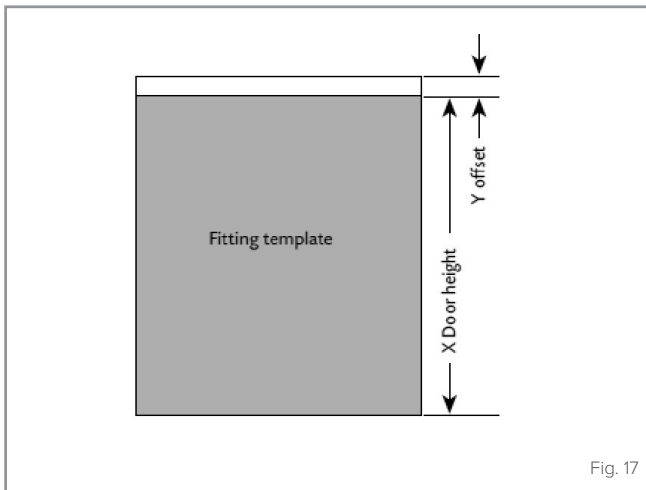

Warranty and service

The manufacturer shall not be held liable for any damage caused by improper use of the product.

- Repairs carried out by unqualified persons may seriously endanger the appliance user
- Pursuant to Commission Regulation (EU) 2019/2023, The minimum availability period for spare parts necessary to repair the appliance is 7 or 10 years depending on the type and purpose of the spare part
- The list of spare parts and the ordering procedure are available on the websites of the manufacturer, importer or an authorised representative
- The minimum warranty period for the appliance offered by the manufacturer, importer or authorised representative is given in the warranty card
- The warranty shall be void if you make any independent adaptations or alterations, tamper with seals or other appliance safety devices or its parts or interfere with the appliance contrary to operating instructions

For more information about the product, please refer to the EU EPREL Product Database at <https://eprel.ec.europa.eu>. Alternatively you can use your mobile device to scan the QR code on the energy label or enter the product model listed on the energy label in the EPREL search engine.

Notes



Serviced by



Built for your life

For our Customer Care Department, or for Service,
please contact us on: