

# Montpellier

THE PERFECT BALANCE OF FUNCTION AND STYLE

LAUNDRY - DISHWASHING - COOKING - COOLING

## Installation and Operating Instructions



### 60cm Semi-Integrated Dishwasher MDI655W/K/X - White - Black - Stainless Steel

Please read these instructions carefully before attempting to install or use this appliance.  
We recommend that you keep these instructions in a safe place for future reference.

# Welcome

---

## Thank you for choosing this Montpellier appliance.

Our appliances have been designed to provide you with the best combination of style, reliability and performance to give you years of trouble-free use.

You may be familiar with a similar product, but please take time to read these instructions carefully before installing or using your appliance to ensure you get the most from your purchase.



**2**  
**YEAR**  
**GUARANTEE**  
— PARTS & LABOUR —  
ACROSS ALL OUR MODELS  
**Montpellier**  
www.montpellier-appliances.com

**We recommend that you keep this manual in a safe place for future reference.**





Your appliance is covered by a comprehensive two year Parts & Labour Guarantee. In the unlikely event that you experience a problem with your appliance, you can rest assured that you are fully protected against the cost of repairs for the first 24 months. Please note that any claim must be accompanied by the model reference number, serial number and proof of purchase.

To activate your guarantee, you will need your product serial number. This can be found inside your appliance.

**NB:** Please make sure that you keep a copy of your original sales invoice as this will be needed if any service call is required.

**There are three ways to register your Guarantee:**

- **Online:** Visit the Support page on our website and complete the online Product Registration form. [www.montpellier-appliances.com](http://www.montpellier-appliances.com)
  - **By Post:** Simply detach and fill in the form provided, attach a stamp and send it in the post. Don't forget to include your e-mail address so that we can send confirmation through to you.
  - **By Phone:** Contact our warranty registration department on **0808 1961388**
- 

Icon	Type	Meaning
	<b>WARNING</b>	Serious injury or death risk
	<b>RISK OF ELECTRIC SHOCK</b>	Dangerous voltage risk
	<b>FIRE</b>	Warning; Risk of fire / flammable materials
	<b>CAUTION</b>	Injury or property damage risk
	<b>IMPORTANT</b>	Operating the system correctly

### Thank you for choosing this product.

This User Manual contains important safety information and instructions on the operation and maintenance of your appliance.

Please take the time to read this User Manual before using your appliance and keep this book for future reference.

The design and specifications are subject to change without prior notice for product improvement.

# CONTENTS

<b>1.SAFETY INSTRUCTIONS</b> .....	<b>1</b>
1.1. General Safety Warnings .....	1
1.2. Installation Warnings .....	2
1.3. During Use.....	3
<b>2.INSTALLATION</b> .....	<b>6</b>
2.1. Machine Positioning .....	6
2.2. Water Connection .....	6
2.3. Water Inlet Hose.....	7
2.4. Drain Hose.....	7
2.5. Electrical Connection .....	7
<b>3.TECHNICAL SPECIFICATIONS</b> .....	<b>8</b>
3.1. General Appearance.....	8
3.2. Technical Specifications .....	8
<b>4.BEFORE USING THE APPLIANCE</b> .....	<b>10</b>
4.1. Preparing your Dishwasher for first use .....	10
4.2. Saltusage.....	10
4.3. Fill the salt .....	10
4.4. Test Strip.....	11
4.5. Water Hardness Table .....	11
4.6. Water Softener System .....	11
4.7. Setting.....	11
4.8. Detergent Usage .....	11
4.9. Filling the Detergent .....	12
4.10. Using Combined Detergents .....	12
4.11. Rinse-aid Usage .....	12
4.12. Filling the Rinse-aid and Setting .....	12
<b>5.LOADING YOUR DISHWASHER</b> .....	<b>13</b>
5.1. Basket Adjustments.....	13
5.2. Alternative Basket Loads .....	14
<b>6.PROGRAMME TABLE</b> .....	<b>15</b>
<b>7.THE CONTROL PANEL</b> .....	<b>16</b>
7.1. Changing a Programme .....	17
7.2. Cancelling a Programme .....	17
7.3. Switching the Machine Off.....	17
<b>8.CLEANING AND MAINTENANCE</b> .....	<b>18</b>
8.1. Filters.....	18
8.2. Spray Arms .....	18
8.3. DrainPump.....	19
<b>9. TROUBLESHOOTING</b> .....	<b>20</b>
<b>10. PRODUCT INFORMATION SHEET</b> .....	<b>23</b>
<b>11. HERE FOR YOU</b> .....	<b>24</b>

# 1. SAFETY INSTRUCTIONS

## 1. General Safety Warnings

- Read these instructions carefully before using your appliance and keep this manual for future reference.

 Please check the packaging of your machine before installation and the outer surface of the machine once the packaging has been removed. Do not operate the machine if it appears damaged or if the packaging has been opened.

- Packaging materials protect your machine from any damage that might occur during transportation. The packaging materials are environmentally friendly as they are recyclable. Use of recycled material reduces raw material consumption and decreases waste production.

 This appliance can be used by children aged from 8 years and above, and by persons with reduced physical, sensory or mental capabilities or lack of experience and knowledge if they have been given supervision or instruction concerning the use of the appliance in a safe way and understand hazards involved. Children should not be allowed to play with the appliance.

 Remove packaging and keep it out of reach of children.

 Keep children away from detergents and rinse aids.

 There may be some residue left in the machine after washing. Keep children away from the machine when it is open.

## 2. Installation Warnings

- Choose a suitable and safe place to install your machine.
- Only original spare parts should be used with the machine.

 Unplug the machine before installation.

 Your machine must only be installed by an authorised service agent. Installation by anyone other than an authorised agent may cause your warranty to be void.

 Check that the indoor electrical fuse system is connected in line with safety regulations.

 All electrical connections must match the values on the plate.

 Ensure the machine does not stand on the electrical supply cable.

 Never use an extension cord or a multiple socket connection.

 The plug should be accessible after the machine is installed.

- After installation, run your machine unloaded for the first time.

 The machine must not be plugged in during positioning.

 Always use the coated plug supplied with your machine.

 If the electrical cable is damaged, it should only be replaced by a qualified electrician.

- Connect the hose directly to the water inlet tap. The pressure supplied by the tap should be a minimum of 0.03 MPa and a maximum of 1 MPa. If the

pressure exceeds 1 MPa, a pressure relief valve must be fitted between the connection.

### 3. During Usage

- This machine is for domestic use only; do not use it for other purposes. Commercial use will void the guarantee.

 Do not stand, sit or place loads on the open door of the dishwasher.

 Only use detergents and rinse aids produced specifically for dishwashers. Our company is not responsible for any damage that may occur due to misuse.

 Do not drink water from the machine.

 Due to the danger of explosion, do not place any chemical dissolving agents into the machine's washing section.

- Check the heat-resistance of plastic items before washing them in the machine.

 Only put items in the machine which are suitable for dishwashing, and take care not to overfill the baskets.

 Do not open the door while the machine is in operation, hot water may spill out. Safety devices ensure the machine stops if the door is opened.



 The machine door should not be left open. It may cause accidents.

 Place knives and other sharp objects in the cutlery basket in a blade-down position.

 For models with the automatic door-opening system, when the EnergySave option is active, the door will open at the end of a program. To prevent damage to your dishwasher, do not attempt to close

the door for one minute after it has opened. For effective drying, keep the door open for 30 minutes after a programme has ended. Do not stand in front of the door after the auto-open signal sounds.



 In the case of a malfunction, repair should only be performed by an authorised service company, otherwise the warranty will be void.

  Before repair work, the machine should be disconnected from the mains. Do not pull the cable to unplug the machine. Switch off the water tap.

 Operation at a low voltage will cause a decline in performance levels.

 For safety, disconnect the plug once a program has finished.

 To avoid an electric shock, do not unplug the machine with wet hands.

  Pull the plug to disconnect the machine from the mains, never pull on the cord.

## **RECYCLING**

- Some machine components and packaging consist of recyclable materials.
- Plastics are marked with the international abbreviations: (>PE<, >PP<, etc. )
- The cardboard parts consist of recycled paper. They can be put into waste paper containers for recycling.
- Material unsuitable for domestic waste must be disposed of at recycling centres.
- Contact a relevant recycling centre to obtain information about disposal of different materials.

## **PACKAGING AND THE ENVIRONMENT**

- Packaging materials protect your machine from damage that may occur during transportation. The packaging materials are environmentally friendly as they are recyclable. The use of recycled material reduces raw material consumption and therefore decreases waste production.

## CE Declaration of Conformity

We declare that our products meet the applicable European Directives, Decisions and Regulations and the requirements listed in the standards referenced.

## Disposal of your old machine



The symbol on the product or on its packaging indicates that this product may not be treated as household waste. Instead, it shall be handed over to the applicable collection point for the recycling of electrical and electronic equipment. By ensuring this product is disposed of correctly, you will help prevent potential negative consequences for the environment and human health, which could otherwise be caused by inappropriate waste handling of this product. For more detailed information about recycling of this product,

please contact your local city office, your household waste disposal service or the shop where the product was purchased.



## 2. INSTALLATION

Complete installation instructions for the appliance and decor door are included within the fitting kit supplied with the appliance(see image below)

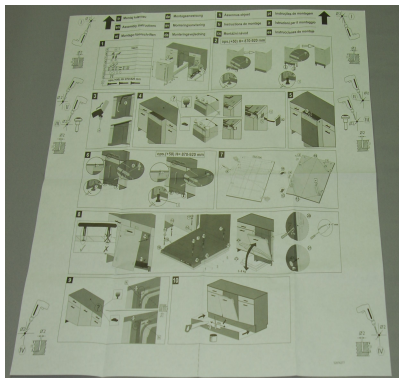

**This fitting guide will need to be saved for future reference in case the appliance is moved or requires re-installing**

### 2.1. Machine positioning

When positioning the machine, place it in an area where dishes can be easily loaded and unloaded. Do not put the machine in an area where the ambient temperature falls below 0°C.

Read all warnings located on the packaging before removing the packaging and positioning the machine.

Place the machine close to a water tap and drain. Take into consideration that the connections will not be altered once the machine is in position.

Do not hold the machine by its door or panel.

The machine should be placed on flat ground otherwise it will be unstable and the door of the machine will not close properly.

Adjustment of the feet must be done once the appliance is in the required position and both the water inlet pipe and the electrical supply are connected. Failure to do this may result in damage to the feet which would not be covered under guarantee. The front feet are adjustable by hand or with the aid of a flat blade screwdriver(see Installation sheet). The rear foot is adjusted by using a screwdriver as per image below.

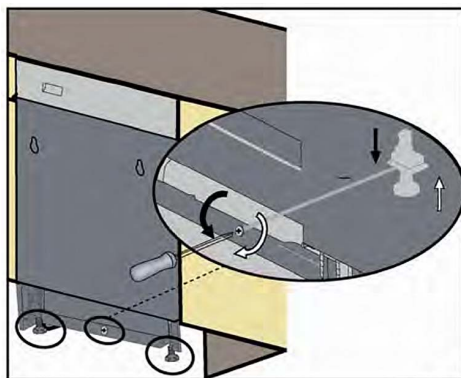

 Ensure the water inlet and outlet hoses are not squeezed, trapped or leaking and that the machine does not stand on the electrical cable or pipes while positioning.

### 2.2. Water connection

We recommend fitting a filter to your water inlet supply in order to prevent damage to your machine due to contamination (sand, rust, etc.) from indoor plumbing. This will also help prevent yellowing and deposit formation after washing.

Note printing on the water inlet hose!  
If models are marked with 25°, the water temperature may be max. 25 °C (cold water).

For all other models:

Cold water preferred; hot water max. temperature 60 °C.

### 2.3. Water inlet hose



**! WARNING:** Use the new water inlet hose supplied with your machine, do not use an old machine's hose.

**! WARNING:** Run water through the new hose before connecting.

**! WARNING:** Connect the hose directly to the water inlet tap. The pressure supplied by the tap should be a minimum of 0.03 MPa and a maximum of 1 MPa. If the pressure exceeds 1 MPa, a pressure relief valve must be fitted between the connection.

**! WARNING:** After the connections are made, turn the tap on fully and check for water leaks. Always turn off the water inlet tap after a wash programme has finished.

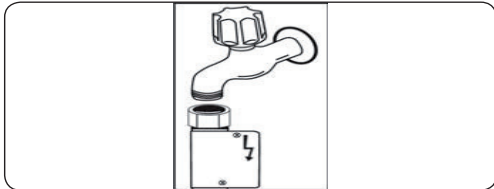

**! WARNING:** An Aquastop water spout is available with some models. Do not damage it or allow it to become kinked or twisted

### 2.4. Drain Hose

Connect the water drain hose directly to the water drain hole or to the sink outlet spigot. This connection should be a minimum of 50cm and a maximum of 110cm from the floor.

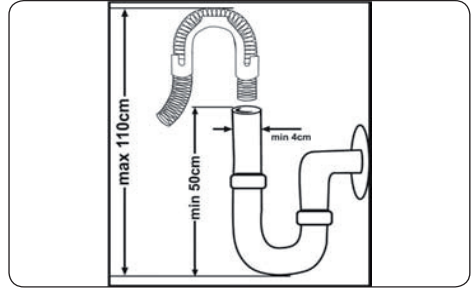

**! IMPORTANT:** Items will not wash properly if the drain hose is longer than 4m.

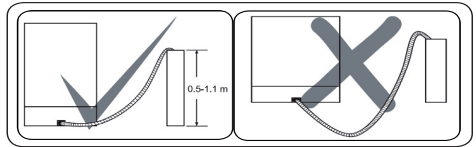

### 2.5. Electrical connection

**! WARNING:** Your machine is set to operate at 220-240 V. If the mains voltage supply to your machine is 110 V, connect a transformer of 110/220 V and 3000 W between the electrical connection.

**! WARNING:** Connect the product to a grounded outlet protected by a fuse complying with the values in the "Technical Specifications" table".

**! WARNING:** The earthed plug of the machine must be connected to an earthed outlet supplied by suitable voltage and current.

**! WARNING:** In the absence of earthing installation, an authorised electrician should carry out an earthing installation. In the case of use without earthing installed, we will not be responsible for any loss of use that may occur.

**! WARNING:** The plug on this appliance will contain a 13A fuse

### 3. TECHNICAL SPECIFICATIONS

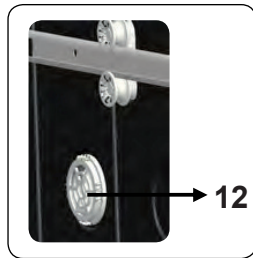
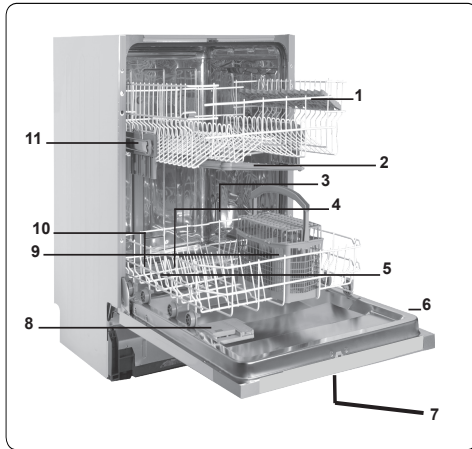

#### 3.1. General appearance

1. Upper basket with racks
2. Upper spray arm
3. Lower basket
4. Lower spray arm
5. Filters
6. Rating plate
7. Control panel
8. Detergent and rinse-aid dispenser
9. Cutlery basket
10. Salt dispenser
11. Upper basket track latch
12. Active Drying Unit: This system enhances the drying performance of your dishes.

#### 3.2. Technical specifications

Capacity	12 place settings
Dimensions (mm)	
Height	820-870(mm)
Width	598(mm)
Depth	570(mm)
Net weight	32,900kg
Operating voltage / frequency	220-240V 50 Hz,
Total current (A)	10(A)
Total power (W)	1900(W)
Water supply pressure	Maximum: 1 (Mpa) Minimum: 0.03 (Mpa)

## RECYCLING

- Some machine components and packaging consist of recyclable materials.
- Plastics are marked with the international abbreviations: (>PE<, >PP<, etc. )
- The cardboard parts consist of recycled paper. They can be put into waste paper containers for recycling.
- Material unsuitable for domestic waste must be disposed of at your local recycling centre.
- Contact a relevant recycling centre to obtain information about disposal of different materials.

## PACKAGING AND THE ENVIRONMENT

- Packaging materials protect your machine from damage that may occur during transportation. The packaging materials are environmentally friendly as they are recyclable. The use of recycled material reduces raw material consumption and therefore decreases waste production.

## CE Declaration of Conformity

We declare that our products meet the applicable European Directives, Decisions and Regulations and the requirements listed in the standards referenced.

## Disposal of Your Old Machine



The symbol on the product or on its packaging indicates that this product may not be treated as household waste. Instead, it shall be handed over to the applicable collection point for the recycling of electrical and electronic equipment. By ensuring this product is disposed of correctly, you will help prevent potential negative consequences for the environment and human health, which could otherwise be caused by inappropriate waste handling of this product. For more detailed information about recycling of this product, please contact your local city office, your household waste disposal service or the shop where the product was purchased.

## 4. BEFORE USING THE APPLIANCE

### 4.1. Preparing your dishwasher for first use

- Make sure the electricity and water supply specifications match the values indicated in the installation instructions for the machine.
- Remove all packaging material inside the machine.
- Set the water softener level and fill the salt compartment.
- Fill the rinse aid compartment.

### 4.2 Salt usage

For a good washing function, the dishwasher needs soft, i.e. less calcareous water. Otherwise, White lime residues will remain on the dishes and the interior equipment. This will negatively affect your machine's washing, drying and shining performance. When water flows through the softener system, the ions forming the hardness are removed from the water and the water reaches the softness required to obtain the best washing result. Depending on the level of hardness of the inflowing water, these ions that harden the water accumulate rapidly inside the softener system. Therefore, the softener system has to be refreshed so that it operates with the same performance also during the next wash. For this purpose, dishwasher salt is used.

Machine can only be used with special dishwasher salt to soften the water. Do not use any small grained or powdered type of salts which are easily soluble.

Use of any other type of salt can damage your machine.

### 4.3. Fill the salt

To add softener salt, open the salt compartment cap by turning it counter clockwise. (1) (2) Before first use, fill the compartment with water (3) to the brim of the container. Pour in 1kg of Dishwasher salt. Using a funnel (4(Not supplied)) will make filling easier. Replace the cap and make sure it is tightened securely. It is advisable to then run the dishwasher through a complete wash cycle to clear the water that has spilled from the container. After every 20-30 Cycles or when the Salt Indicator light appears on the control panel add salt (approx. 1 kg). Do not over fill the compartment so that it is completely full of salt.

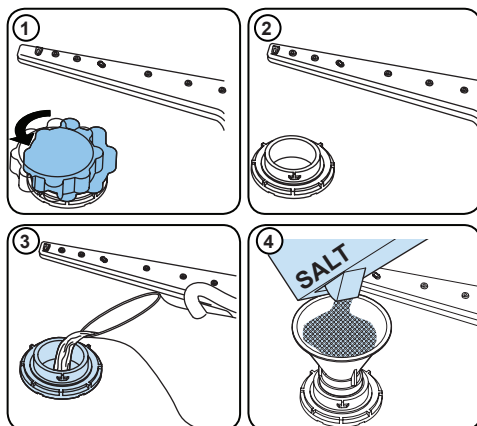



#### **Only add water to the salt compartment on first use.**

Use softener salt specifically produced for use in dishwashers.

When you start your dishwasher, the salt compartment will fill with water, therefore put the softener salt in prior to starting your machine.

If the softener salt has overflowed and you do not start the machine immediately, run a short washing program to protect your machine against corrosion.

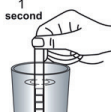
#### 4.4. Test Strip

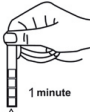
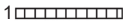
Run water through the tap (1min.)	Keep the strip in the water (1sec)	Shake the strip.	Wait (1min.)	Set the hardness level of your machine.
				

**NOTE:** The level is set to 3 as default. If the water is well water or has a hardness level above 90 dF, we recommend that you use filter and refinement devices.

#### 4.5. Water Hardness Table

Level	German dH	French dF	British dE	Indicator
1	0-5	0-9	0-6	L1 is shown on the display.
2	6-11	10-20	7-14	L2 is shown on the display.
3	12-17	21-30	15-21	L3 is shown on the display.
4	18-22	31-40	22-28	L4 is shown on the display.
5	23-34	41-60	29-42	L5 is shown on the display.
6	35-50	61-90	43-63	L6 is shown on the display.

#### 4.6. Water Softener System

The dishwasher is equipped with a water softener which reduces the hardness in the mains water supply. To find out the hardness level of your tap water, contact your water company or use a test strip (if available).

#### 4.7. Setting

- Close the dishwasher door and make sure that the control knob is set to “off”
- Press and hold the “Start/Pause” button, while still pressing the “Start/Pause” button turn the control knob clockwise to the Prewash Programme until the LED display shows “SL” and all 4 lights above the display illuminate, then you can release the “Start/Pause” button.
- Using the + & - buttons you can then set the required level (1-6).
- Once the required level is set then turn the appliance off with the control knob “O”

#### 4.8. Detergent usage

Only use detergents specifically designed for domestic dishwashers. Keep your detergents in cool, dry places out of reach of children.

Add the proper detergent for the selected program to ensure the best performance. The amount of detergent needed depends on the cycle, load size, and soil level of dishes.

Do not fill detergent into the detergent compartment more than required; otherwise you can see whitish streaks or bluish layers on glass and dishes and may cause glass corrosion. Continued use of too much detergent may cause machine damage.

Using too little detergent can result in poor cleaning and you can see whitish streaks in hard water.

See the detergent manufacturer's instructions for a further information.

#### 4.9. Filling with detergent

Push the button on the cap to open the dispenser and pour in the detergent.

To close the cap slide and press it until it locks in place. The dispenser should be refilled just before the start of each programme.

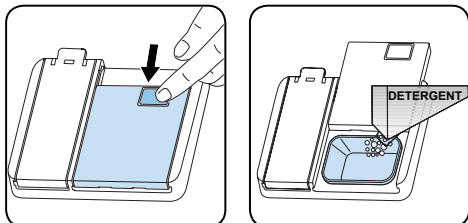

#### 4.10. Using combined detergents

These products should be used according to the manufacturer's instructions.

When using combined detergents it is important to reduce the salt and rinse aid level to the lowest setting.

Never put combined detergents into the interior section or the cutlery basket.

Combined detergents contain not only the detergent but also rinse-aid, salt replacement substances and additional components depending on the combination.

We recommend you do not use combined detergents in short programmes. Please use powder detergents in such programmes.

If you encounter problems when using combined detergents, please contact the detergent manufacturer.

When you stop using combined detergents, make sure that water hardness and rinse aid settings are set to the required level.

#### 4.11. Rinse-aid usage

The rinse aid helps to dry the dishes without streaks and stains. Rinse-aid is required for stain-free utensils and clear glasses. The rinse aid is automatically released during the hot rinse phase. If rinse aid dosage setting is set too low, whitish stains remain on dishes and dishes do not dry or wash properly.

If rinse aid dosage setting is set too high, you can see bluish layers on glass and dishes.

#### 4.12. Filling the rinse-aid and setting

To fill the rinse aid compartment, open the rinse-aid compartment cap. Fill the compartment with rinse aid to the MAX level and then close the cap. Be careful not to overflow the rinse aid compartment, if this happens run the dishwasher through a short cycle

**In order to change the rinse aid level, follow the below steps before turning on the machine:**

- Close the dishwasher door and make sure that the control knob is set to "off"
- Press and hold the "Start/Pause" button, while still pressing the "Start/Pause" button turn the control knob anti-clockwise to the Hygiene 70°C Programme until the LED display shows "RA" and all 4 lights above the display illuminate, then you can release the "Start/Pause" button.
- Using the + & - buttons you can then set the required level (1-5).
- Once the required level is set then turn the appliance off with the control knob "O"

The factory setting is "4".

If the dishes are not drying properly or are spotted, increase the level. If blue stains form on your dishes, decrease the level.

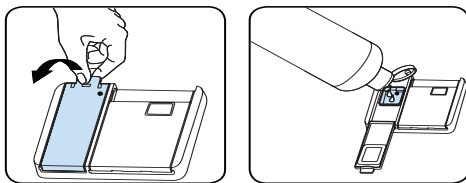

Level	Brightener Dose	Indicator
1	Rinse-aid not dispensed	r1 is shown on the display.
2	1 dose is dispensed	r2 is shown on the display.
3	2 doses are dispensed	r3 is shown on the display.
4	3 doses are dispensed	r4 is shown on the display.
5	4 doses are dispensed	r5 is shown on the display.

## 5. LOADING YOUR DISHWASHER

For best results, follow these loading guidelines.

Loading the household dishwasher up to the capacity indicated by the manufacturer will contribute to energy and water savings.

Manual pre-rinsing of tableware items leads to increased water and energy consumption and is not recommended.

Remove any coarse residue/food on dishes before placing the dishes in the machine. Start the machine with a full load.

You can place cups, glasses, stemware, small plates, bowls, etc. in upper basket. Do not lean long glasses against one another or they cannot remain steady and may receive damage.

When placing long stem glasses and goblets, lean them against the basket edge or rack and not against other items.

Place all containers such as cups, glasses and pots into the dishwasher with the opening facing downwards otherwise water can collect on items.

If there is a cutlery basket in the machine, you are recommended to use the cutlery grid in order to obtain the best result. Place all large (pots, pans, lids, plates, bowls etc.) and very dirty items in the lower rack.

Dishes and cutlery should not be placed above each other.

 **WARNING:** Take care not to obstruct the rotation of spray arms.

 **WARNING:** Make sure after loading the dishes do not prevent the opening of the detergent dispenser.

 Do not overload the drawers or place dishes in the wrong basket.

 **WARNING:** To avoid any possible injuries, place long-handle and sharp-pointed knives with their sharp points facing down or horizontally on the baskets.

## 5.1. Basket Adjustments

### Upper Basket Height adjustment

If you find the upper spray arm is hitting items in the lower basket or you require more height in the top basket, follow the directions below to adjust the basket height accordingly

Turn the Rail Stop Clips, at the ends of the rails, to the sides to open them (see image **A** below), then pull out and remove the basket.

Change the position of the wheels (see image **B** below), then reinstall the basket to the rail, making sure to close the Rail Stop Clips.

When the upper basket is in the higher position, large items such as pans can be placed on the lower basket.

**After any adjustments of the upper basket make sure that the upper spray arm rotates freely.**

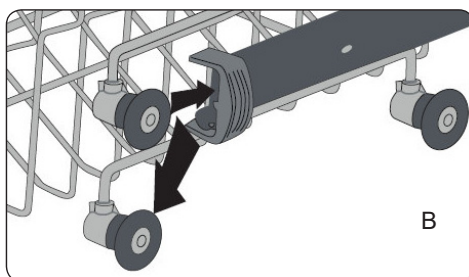
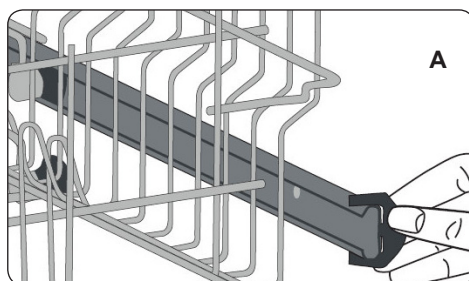



### Height Adjustable Rack (peg type)

The height adjustable racks enable glasses and cups to be placed on or under the racks. The racks can be adjusted to 2 different heights. Cutlery and utensils can also be placed on the racks horizontally.

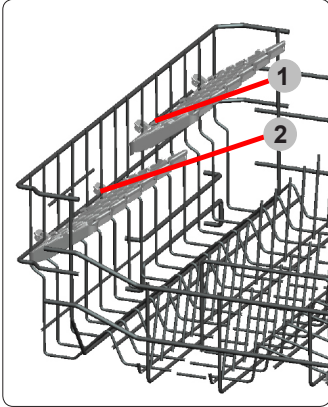

### 5.2. Alternative Basket Loads

#### Lower basket

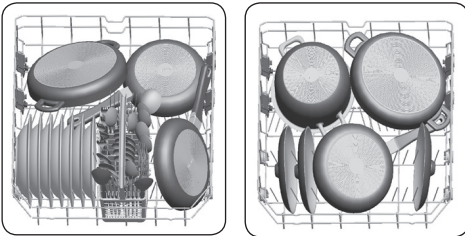

#### Upper basket

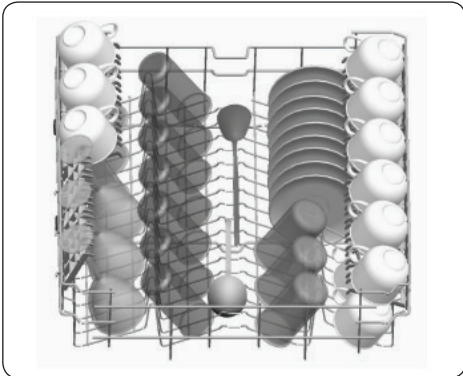

### Incorrect Loads

Incorrect loading can cause poor washing and drying performance. Please follow the manufacturer's recommendations for the best cleaning performance results.

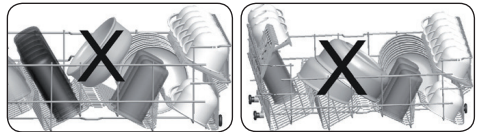
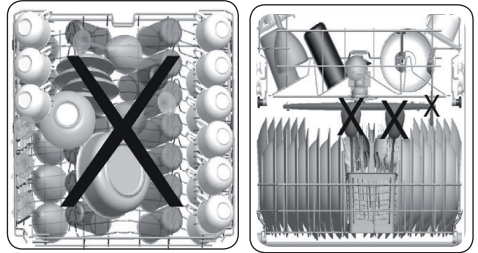

### Unsuitable items for dishwashing

- Cigarette ashes, candle leftovers, polish, paint, chemical substances, iron-alloy materials.
- Forks, spoons and knives with wooden, bone, ivory or nacrecoated handles; glued items, items soiled with abrasive, acidic or base chemicals.
- Temperature-sensitive plastics, copper or tincoated containers.
- Aluminium and silver objects.
- Some delicate glasses, ornamental printed porcelains; some crystal items, adhered cutlery, lead crystal glasses, cutting boards, synthetic fibred items.
- Absorbent items such as sponges or kitchen rugs.









**IMPORTANT:** In future, purchase dishwasher-proof kitchenware.

### Important Note for Test Laboratories

For detailed information required for tests according to EN normatives and a softcopy of the manual, please send the model name and serial number to the following address: [dishwasher@standardtest.info](mailto:dishwasher@standardtest.info)

## 6. PROGRAMME TABLE

	P1	P2	P3	P4	P5	P6	P7
Program Name:	Prewash	Quick 30' 40°C	Delicate 40°C	Eco	Super 50'	Intensive 65°C	Hygiene 70°C
Program Icon:							
Type of Soil:	Suitable to rinse dishes that you plan to wash later.	Suitable for lightly soiled dishes and quick wash.	Suitable for lightly soiled delicate dishes.	Standard program for normally soiled daily using dishes with reduced energy and water consumptions.	Suitable for normally soiled daily dishes with faster program.	Suitable for heavily soiled dishes.	Suitable for heavily soiled dishes requiring hygienic washing.
Level of Soil:	Light	Light	Light	Medium	Medium	Heavy	Heavy
Amount of Detergent: A: 25 cm <sup>3</sup> B: 15 cm <sup>3</sup> "	-	A	A	A	A	A	A
Program Duration (h:min)	00:15	00:30	01:14	03:41	00:50	01:57	02:07
Electricity consumption (kWh/cycle)	0.020	0.740	0.880	0.923	1.100	1.700	1.900
Water consumption (l/cycle)	4.5	12.4	16.0	9.0	12.0	17.2	16.0

- The program duration may change according to the amount of dishes, the water temperature, the ambient temperature and selected additional functions.
- Values given for programmes other than the eco programme are indicative only
- Eco programme is suitable to clean normally soiled tableware, that for this use, it is the most efficient programme in terms of its combined energy and water consumption, and that it is used to assess compliance with the EU ecodesign legislation.
- Washing tableware in a household dishwasher usually consumes less energy and water in the use phase than hand dishwashing when the household dishwasher is used according to the manufacturer's instructions.
- Only use powder detergent for short programs.
- Short programs do not include drying.
- To assist drying, we recommend slightly opening the door after a cycle is complete.
- You can access the product database where the model information is stored by reading the QR code on the energy label.



**NOTE:** According to regulations 1016/2010 and 1059/2010, Eco program energy consumption values may differ. This table is in line with regulations 2019/2022 and 2017/2022.

## 7. THE CONTROL PANEL

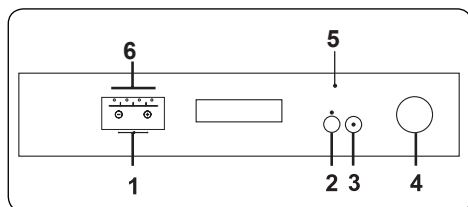

Rotate the Programme Selection Knob (4) to switch on the machine and select a suitable programme for your dishes. When the Programme Selection Knob is in the 'Off' position, the machine will not operate.

Press the Start/Pause button (3) to start the selected programme. The Start/Pause light will switch off and the Wash light will illuminate. If the door of your machine is opened during washing, the Start/Pause light will flash and the Wash light will remain illuminated.

The Wash, Rinse, Dry and End lights (6) on the Control Panel indicate the status of the programme in operation. The machine will remain silent for 40 to 50 minutes while the Drying light is on.

The Remaining Time Indicator (1) shows the duration of the selected programme and the time remaining of the programme in operation.

**NOTE:** If an extra feature has been used, such as Delay or Half Load (1, 2), on the most recent wash programme, this feature will remain active on the next selected programme. To cancel this feature on the newly selected wash programme, turn the Programme Selection Knob to the 'Off' position, then turn it to select a programme. Extra features can be activated with the newly selected programme.

**NOTE:** Simultaneously press the "+" and "-" buttons for 3 seconds to activate/deactivate the Child Lock. When it is first activated, "CL" will show on the Remaining Time Indicator for 2 seconds. When it is deactivated, "CL" will flash twice.

**NOTE:** When there is insufficient rinse aid, the Rinse Aid Lack Warning Indicator (5) will illuminate, indicating the rinse aid chamber needs filling.

### Delaying a Programme

Before a programme starts, press the "+" or "-" button on the Remaining Time Indicator (1) to delay the start time of a programme for 1 hour up to 19 hours. To change the delay time, first press the Start/Pause button, then use the "+" and "-" buttons to select a new delay time. To activate the new delay time, press the Start/Pause button. To cancel the delay time, use the "+" and "-" buttons to set the time to '0'.

**NOTE:** If the Programme Selection Knob is turned to the 'Off' position after the delay time has been selected and the programme started, the remaining delay time is stored. When the knob is turned to a new programme, the remaining delay time will resume.

### Half Load

Press the Half Load button (2) to select the half load option. You can load the dishwasher using both baskets. Half Load will reduce time, water and energy usage. If a programme is incompatible with the Half Load function, a buzzer will sound.

## 7.1. Changing a Programme

Follow the steps below to change the programme while in operation.

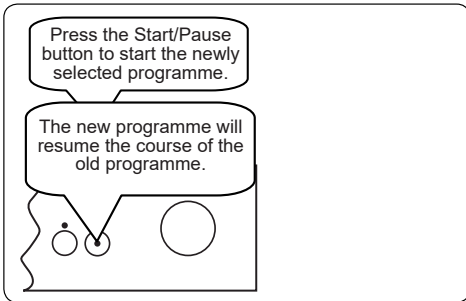
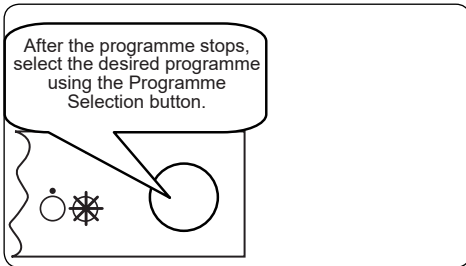
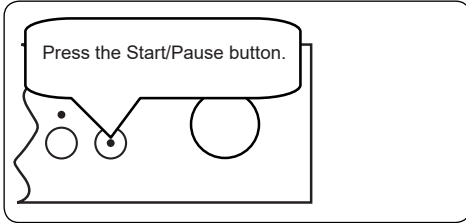

## 7.2. Cancelling a Programme

Follow the steps below to cancel a programme while in operation.

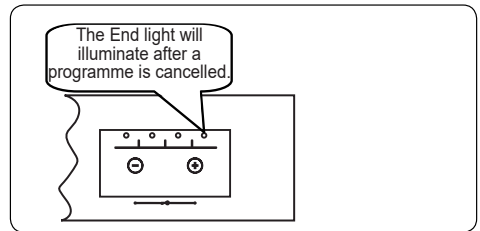
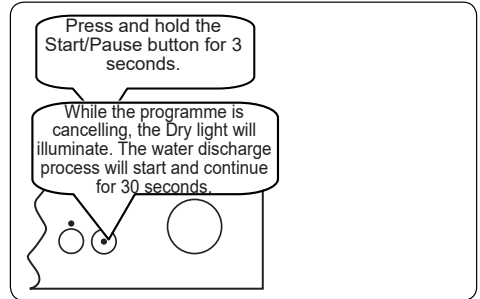

## 7.3. Switching the Machine Off

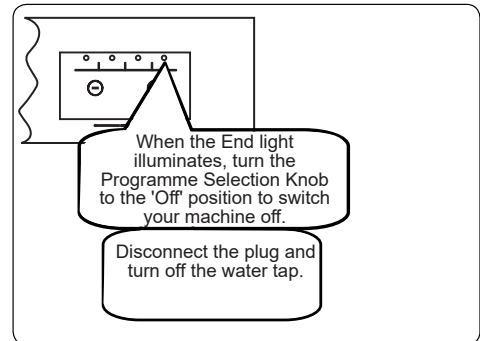

**NOTE:** Do not open the door before the programme is complete.

**NOTE:** Leave the machine door slightly open at the end of a wash programme to speed up the drying process.

**NOTE:** If the door of the machine is opened or the power is cut off during a wash programme, the programme will continue when the door is closed or when the power returns.

## 8. CLEANING AND MAINTENANCE

Cleaning your dishwasher is important to maintain the machine's service life. Make sure that the water softening setting (If available) is done correctly and correct amount of detergent is used to prevent limescale accumulation. Refill the salt compartment when the salt sensor light comes on.

Oil and limescale may build up in your Dishwasher over time. If this occurs:

- Fill the detergent compartment but do not load any dishes. Select a programme which runs at high temperature and run the Dishwasher empty. If this does not clean your Dishwasher sufficiently, use a cleaning agent designed for use with dishwashers.
- To extend the life of your dishwasher, clean the appliance regularly
- Wipe the door seals regularly with a damp cloth to remove any accumulated residue or foreign objects.

### 8.1. Filters

Clean the filters and spray arms at least once a week. If any food waste remains or foreign objects on the coarse and fine filters, remove them and clean them thoroughly with water.

- a) Micro Filter    b) Coarse Filter  
c) Metal Filter

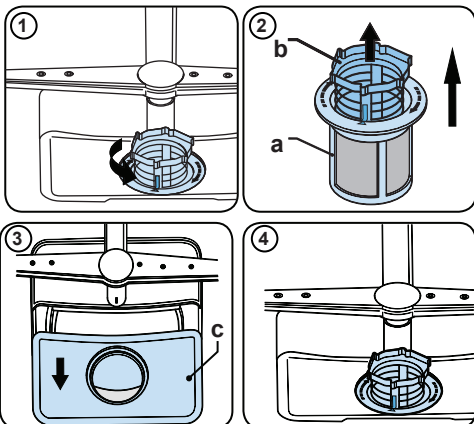

To remove and clean the filter combination, turn it counter clockwise and remove it by lifting it upwards **(1)**. Pull the coarse filter out of the micro filter **(2)**. Then pull and remove the metal filter **(3)**. Rinse the filter with lots of water until it is free of residue. Reassemble the filters. Replace the filter insert, and rotate it clockwise **(4)**.

- Never use your dishwasher without a filter.
- Incorrect fitting of the filter will reduce the washing effectiveness.
- Clean filters are necessary for proper running of the machine.

### 8.2. Spray arms

Make sure that the spray holes are not clogged and that no food waste or foreign object is stuck to the spray arms. If there is any clogging, remove the spray arms and clean them under water. To remove the upper spray arm undo the nut holding it in position by turning it clockwise and pulling it downwards. Make sure that the nut is properly tightened when refitting the upper spray arm.

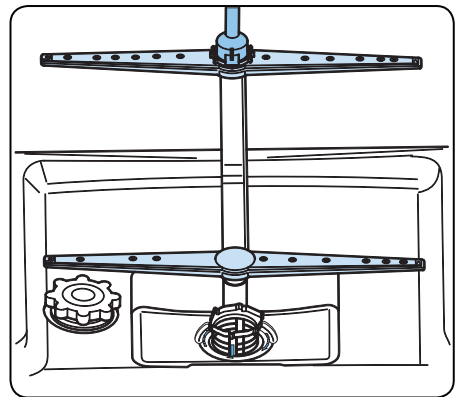

### 8.3 Drain Pump

Large food residues or foreign objects which were not captured by the filters may block the waste water pump. The rinsing water will then be above the filter.

 Warning Risk of cuts!

When cleaning the waste water pump, ensure that you do not injure yourself on pieces of broken glass or pointed implements.

In this case:

1. First always disconnect the appliance from the power supply.
2. Take out baskets.
3. Remove the filters.
4. Scoop out water, use a sponge if required.
5. Check the area and remove any foreign objects.
6. Install filters.
7. Re-insert baskets.

If this does not rectify the fault you will need to call call for service

## 9. TROUBLESHOOTING

FAULT	POSSIBLE CAUSE	TROUBLESHOOTING
The programme does not start.	Your Dishwasher is not plugged in.	Plug your Dishwasher in.
	Your Dishwasher is not switched on.	Switch your Dishwasher on by pressing the On/Off button.
	Fuse blown.	Check your indoor fuses.
	Water inlet tap is closed.	Turn on the water inlet tap.
	Your Dishwasher door is open.	Close the Dishwasher door.
	Water inlet hose and machine filters are clogged.	Check the water inlet hose and machine filters and make sure they are not clogged.
Water remains inside the machine.	Water drain hose is clogged or twisted.	Check the drain hose, then either clean or untwist it.
	The filters are clogged.	Clean the filters.
	The programme is not finished yet.	Wait until the programme is finished.
Machine stops during washing.	Power failure.	Check mains power.
	Water inlet failure.	Check water tap.
Shaking and hitting noises are heard during a wash operation.	The spray arm is hitting the dishes in the lower basket.	Move or remove items blocking the spray arm.
Partial food wastes remain on the dishes.	Dishes placed incorrectly, sprayed water not reaching affected dishes.	Do not overload baskets.
	Dishes leaning each another.	Place dishes as instructed in the section on loading your dishwasher.
	Not enough detergent used.	Use the correct amount of detergent, as instructed in the programme table.
	Wrong wash programme selected.	Use the information in the programme table to select the most appropriate programme.
	Spray arms clogged with food waste.	Clean the holes in the spray arms with thin objects.
	Filters or water drain pump clogged or filter misplaced.	Check the drain hose and filters are correctly fitted.

FAULT	POSSIBLE CAUSE	TROUBLESHOOTING
Whitish stains remains on dishes.	Not enough detergent used.	Use the correct amount of detergent, as instructed in the programme table.
	Rinse aid dosage and/or water softener setting set too low.	Increase rinse aid and/or water softener level.
	High water hardness level.	Increase water softener level and add salt.
	Salt compartment cap not closed properly.	Check that the salt compartment cap is closed properly.
Dishes do not dry.	Drying option is not selected.	Select a programme with a drying option.
	Rinse aid dosage set too low.	Increase rinse aid dosage setting.
Rust stains form on the dishes.	Stainless-steel quality of the dishes is insufficient.	Use only dishwasher-proof sets.
	High level of salt in wash water.	Adjust the water hardness level using water hardness table.
	Salt compartment cap not closed properly.	Check that the salt compartment cap is closed properly.
	Too much salt spilled in the Dishwasher while filling it with salt.	Use funnel while filling salt to the compartment to avoid spillage.
	A poor mains grounding.	Consult a qualified electrician immediately.
Detergent remains in the detergent compartment.	Detergent was added when the detergent compartment was wet.	Make sure detergent compartment is dry before use.



## AUTOMATIC FAULT WARNINGS AND WHAT TO DO

TROUBLE CODE	POSSIBLE FAULT	WHAT TO DO
FF	Water inlet system failure	Make sure the water inlet tap is open and water is flowing.
		Separate the inlet hose from the tap and clean the filter of the hose.
		Contact for service if the error continues.
F5	Pressure system failure	Contact for service.
F3	Continuous water input	Close the tap and contact for service.
F2	Inability to discharge water	Water discharge hose and filters may be clogged.
		Cancel the program.
		If the error continues, contact for service.
F8	Faulty heater	Contact for service.
F1	Overflow	Unplug the machine and close the tap.
		Contact for service.
F7	Overheating failure	Contact for service.
F6	Faulty temperature sensor	Contact for service.
FE	Faulty electronic card	Contact for service.

The installation and repairing procedures should always be carried out by the Authorised Service Agent in order to avoid possible risks. The manufacturer shall not be held liable for damages that may arise from procedures carried out by unauthorised persons. Repairs may be carried out by technicians only. If a component has to be replaced, ensure that only original spare parts are used.

Improper repairs or use of non-original spare parts may cause considerable damage and put the user at considerable risk.

Contact information for your customer service can be found on the back of this document.

**Model identifier: MDI655W/K/X**

**General product parameters:**

Parameter	Value	Parameter	Value	
Rated capacity (ps)	12	Dimensions in cm	Height	82
			Width	598
			Depth	57
EEL	55.9	Energy efficiency class	E	
Cleaning performance index	1.13	Drying performance index	1.07	
Energy consumption in kWh [per cycle], based on the eco programme using cold water fill. Actual energy consumption will depend on how the appliance is used.	0.923	Water consumption in litres [per cycle], based on the eco programme. Actual water consumption will depend on how the appliance is used and on the hardness of the water.	9	
Programme duration (h:min)	3:41	Type	Built-in	
Airborne acoustical noise emissions (dB(A) re 1 pW)	49	Airborne acoustical noise emission class	C	
Off-mode (W)	0.5	Standby mode (W)	1	
Delay start (W) (if applicable)	-	Networked standby (W) (if applicable)	-	

**Minimum duration of the guarantee offered by the supplier: 24 months**

**Additional information:**

Weblink to the supplier's website, where the information in point 6 of Annex II to Commission Regulation (EU) 2019/2022 is found: <https://www.montpellier-appliances.com/?s=mdi655>

# Here For You

## After-sales assistance

If you continue to experience problems with your appliance, please call the Montpellier customer service helpline on: **01759 487839**

Please have all your product details available, including the model number, serial number, original sales invoice (clearly showing model number, date of purchase and your retailer's details) before registering a fault.

The service call cannot progress without this information.

## Your 2 year Manufacturer's guarantee

THIS DOES NOT AFFECT YOUR STATUTORY RIGHTS.

Your new Montpellier appliance carries a free guarantee which protects you against the cost of repairs during the first 24 months from date of purchase provided that:

Any claim is accompanied by evidence of the model reference, model serial number and proof of purchase, such as a Sales Receipt, showing that the appliance was purchased within the 24 months prior to the date of claim.

### What is not covered under the Guarantee

- Any appliance not correctly installed and operated in accordance with the manufacturer's instructions
- Any appliance that is used for anything other than domestic purposes.  
Any defect caused by accident, misuse, unauthorised modification or inexpert repair.
- Cost of Call-out where a fault cannot be found with the appliance.  
Cost of Call-out for work covering routine maintenance, such as, but not exclusively, cleaning of filters or defrosting.
- Cost of Call-out for work required to correct the alignment of doors following door reversal procedures carried out by you.  
Use of the appliance by anyone other than the Householder.  
Use in any commercial environment.
- Consumable items, such as, but not exclusively, fuses in plugs, bulbs and breakable items which require routine replacement.  
Repair costs incurred that have not been authorised by Montpellier service and/or carried out by a non-approved Montpellier engineer.
- Montpellier Appliances do not accept claims for consequential loss, rusting, corroding, delivery damage or scratches.

### YOUR GUARANTEE IS VALID ONLY IN THE UK.

To register your appliance simply complete the card in your appliance pack and return it with a stamp affixed or alternatively you can register online at [www.montpellier-appliances.com/support](http://www.montpellier-appliances.com/support)

## SERVICE HELP-LINE

Should your appliance develop a fault, please call the Montpellier customer service helpline on:

**01759 487839**

Please remember to have all your product details available, including the model number, serial number, date of purchase and your retailer's details before registering a fault.

**Montpellier Domestic Appliances Ltd.**  
Unit 1, Tewkesbury Retail Park, Northway Lane,  
Tewkesbury, Gloucestershire GL20 8JU

[www.montpellier-appliances.com](http://www.montpellier-appliances.com)



The symbol on the product or on its packaging indicates that this product may not be treated as household waste. Instead it shall be handed over to the applicable collection point for the recycling of electrical and electronic equipment. By ensuring this product is disposed of correctly, you will help prevent potential negative consequences for the environment and human health, which could otherwise be caused by inappropriate waste handling of this product. For more detailed information about recycling of this product, please contact your local city office, your household waste disposal service or the shop where you purchased the product.